

Blaster Master: Blasting Again FAQ/Walkthrough

by PRadley

Updated to v1.0 on Feb 20, 2009

```
=====  
][ Blaster Master Blasting Again Walkthrough ][  
=====
```

by Paul Radley
Loberto_E@hotmail.com
Version 1.0
May 28, 2002

```
=====
```

LEGAL

This document is copyright 2002 by Paul Radley. It is intended for personal use only. This document may not be reproduced, in part or whole, for commercial use or otherwise, without the express written consent of the author. Blaster Master is (c) 2001 by Sun Corporation. All other products, trademarks, etc. contained here within remain the sole property of those corporations and other lucky bastards who own them (Sun Corp, Sunsoft, Crave, Sony, etc.) ;)

```
=====
```

Table of Contents

```
-----
```

1.0	Version History
2.0	Forward
2.1	Notes from the Author
2.2	Review
2.3	Using This FAQ
3.0	The Story Thus Far...
3.1	History
3.2	Prelude
4.0	Interface
4.1	Gameplay
4.1.1	Environment
4.1.2	Movement
4.1.3	Navigation
4.1.4	Item Collection
4.1.5	Item List
4.2	Sophia
4.2.1	Controls
4.2.2	Upgrades
4.3	Roddy
4.3.1	Controls
4.3.2	Weapon Upgrades
5.0	Walkthrough
5.1	Intro
5.1.1	Options
5.1.1	New Game
5.2	Mission 1 - Cave
5.2.1	Ground Map
5.2.2	Ground

- 5.2.3 Cave Map
- 5.2.4 Cave
- 5.2.5 Cave Gate 1 Map
- 5.2.6 Cave Gate 1
- 5.2.7 Boss
- 5.3 Mission 2 - Water
 - 5.3.1 Rewards
 - 5.3.2 Ground
 - 5.3.3 Water Map
 - 5.3.4 Water
 - 5.3.5 Water Gate 1 Map
 - 5.3.6 Water Gate 1
 - 5.3.7 Water cont.
 - 5.3.8 Water Gate 2 Map
 - 5.3.9 Water Gate 2
 - 5.3.10 Water cont. some more
 - 5.3.11 Water Gate 3 Map
 - 5.3.12 Water Gate 3
- 5.4 Mission 3 - Plant
 - 5.4.1 Rewards
 - 5.4.2 Ground
 - 5.4.3 Plant Map
 - 5.4.4 Plant
 - 5.4.5 Plant Gate 1 Map
 - 5.4.6 Plant Gate 1
 - 5.4.7 Plant cont.
 - 5.4.8 Plant Gate 2 Map
 - 5.4.9 Plant Gate 2
 - 5.4.10 Plant cont. some more
 - 5.4.11 Plant Gate 3 Map
 - 5.4.12 Plant Gate 3
- 5.5 Mission 4 - Lava
 - 5.5.1 Rewards
 - 5.5.2 Ground
 - 5.5.3 Lava Map
 - 5.5.4 Lava
 - 5.5.5 Lava Gate 1 Map
 - 5.5.6 Lava Gate 1
 - 5.5.7 Lava cont.
 - 5.5.8 Lava Gate 2 Map
 - 5.5.9 Lava Gate 2
 - 5.5.10 Lava cont.
 - 5.5.11 Lava Gate 3 Map
 - 5.5.12 Lava Gate 3
 - 5.5.13 Lava cont.
 - 5.5.14 Lava Gate 4 Map
 - 5.5.15 Lava Gate 4
- 5.6 Mission 5 - Water part 2
 - 5.6.1 Rewards
 - 5.6.2 Ground
 - 5.6.3 Water
 - 5.6.4 Water part 2 Map
 - 5.6.5 Water 2
 - 5.6.6 Water 2 Gate 1 Map
 - 5.6.7 Water 2 Gate 1
 - 5.6.8 Boss
- 5.7 Mission 6 - Cave part 2
 - 5.7.1 Rewards
 - 5.7.2 Ground
 - 5.7.3 Cave part 2 Map

- 5.7.4 Cave 2
- 5.7.5 Cave 2 Gate 2 Map
- 5.7.6 Cave 2 Gate 2
- 5.8 Mission 7 - Lava part 2
 - 5.8.1 Rewards
 - 5.8.2 Scavenge
 - 5.8.3 Lava part 2 Map
 - 5.8.4 Lava 2
 - 5.8.5 Lava 2 Gate 1 Map
 - 5.8.6 Lava 2 Gate 1
 - 5.8.7 Boss
- 5.9 Mission 8 - Plant part 2
 - 5.9.1 Ground
 - 5.9.2 Plant part 2 Map
 - 5.9.3 Plant 2
 - 5.9.4 Plant 2 Gate 1 Map
 - 5.9.5 Plant 2 Gate 1
- 5.10 Final Confrontation
- 6.0 Bonuses
 - 6.1 Sophia III
 - 6.2 Movies
- 7.0 Enemy Compendium
 - 7.1 Underworld
 - 7.2 Gate
 - 7.3 Bosses
- 8.0 Credits and Final Word

=====

1.0 Version History

- v.1.0 - 5/28/02 - FAQ complete - Remaining ancillary information added and final edit completed
- v.0.8 - 5/27/02 - Maps completed and some ancillary information added.
 - First submission to Gamefaqs
 - Remaining front-matter needs to be added
 - Final edit still needs to be completed
- v.0.7 - 5/23/02 - Game Walkthrough completed
- v.0.1 - 5/9/02 - ...and so it begins.

=====

2.0 Foreword

2.1 Notes from the Author

This is my first faq. It seems to me that this is the traditional way to start one of these, and I wonder if I write more, if I will be forced to start them with the same opening line. Having revealed my inexperience in this realm, I welcome constructive feedback from those who take the time to read this work. Feel free to email me with any nuances I left out, or glaring errors that I missed, or any outstanding questions you may have that were not addressed. I am a big fan of the first Blaster Master game, one of my favorite NES titles. It pleases me that Sunsoft brought the story to the PlayStation in a manner that stays true to the concept and fun nature of the original game. While BMBA certainly isn't a breakthrough game technologically, nor a Pulitzer-caliber story, it is good entertainment that, I think, honors its heritage.

2.2 Review

Blaster Master Blasting Again (BMBA) is a third-person 3D platformer that puts the player at the controls of the high-tech, all-terrain combat vehicle Sophia J-7. You must navigate through several areas of caverns to uncover and ultimately stop the treacherous plans of a mysterious alien race of Lightning Beings. But sometimes having futuristic artillery isn't enough, and you must exit Sophia and go solo through alien complexes. As the game progresses you will earn upgrades for your vehicle, and be able to salvage weapon upgrades for the pilot. You will also be treated to movie cut-scenes that help convey the key elements in the story. At the end of each stage of the game you will be faced with a boss. Bosses in BMBA are large creatures with separate health gauges for their various limbs, components, or parts. Bosses will be encountered both while driving Sophia and while exploring outside the vehicle. The gameplay is simple, though vulnerable to frustrations inherent to 3D platformers. The camera works well when in the vehicle, but having dismounted, the camera becomes cumbersome. Targeting while running is also difficult since there is no real strafing feature. The graphics are not incredibly detailed, nor are the textures very striking, but models are original and varied, and some environments are really well done. The game loads between each room, which can become very annoying, but load times can be shortened if playing on the PS2 changing the disc speed on the PS driver. Sound effects and music are appropriate, but tend to be recycled throughout the game, though each level has it's own background theme. The game can be played in three difficulty settings, adding to the challenge and offering some additional replay value. Overall, I think BMBA is a fun game to play. A good renter to those looking for a light action game, and worth buying for fans of the Blaster Master legend. It's not as pretty or fast paced as the original NES title, but it does not embarrass the legacy.

2.3 Using This FAQ

This faq is developed as a walkthrough. The game is broken up into sequences that I have labeled as Missions. Each mission takes place primarily in a different area, which I have mapped and included at the beginning of the first section regarding that area. The areas are comprised of different rooms which I have numbered and labeled on the maps. The walkthrough provides a path through the game that will take you through every room in the most efficient manner. Room descriptions, complete with enemies (which reset themselves each time you enter the room) and special items that must be interacted with (switches, etc.) are listed only at the first appearance of the room. If the room needs to be entered a second time, additional descriptions will only be given if circumstances warrant it. A description of all the enemies, including the bosses, along with strategies on how to fight them, is included at the end of the faq. Note that the content of this walkthrough is based on a Normal difficulty game.

3.0 The Story Thus Far...

3.1 History

There once was a boy named Jason, who had a pet frog. One day the frog, bored with his microenvironment, decided to explore the world. Hopping outside, he fell into a mysterious hole in the backyard. The tiny frog landed on a pile of boxes containing radioactive materials. The exposure to the materials led to an immediate mutation, and the frog

swelled to ten times his original size. Unfazed, the big frog hopped off down the mysterious tunnel he found himself in, to see what he could see. Jason, meanwhile, upset at his pet's disappearance, began searching frantically. He too found the mysterious hole, but when he reached the bottom, there was a strange vehicle waiting for him - Sophia III. And, since nobody else was around, Jason thought he'd drive Sophia around to look for his frog. Donning a battle suit he finds with the vehicle, Jason embarks on a journey that will forever change his life.

Jason encounters an alien race, known as the Lightning Beings, living in caverns beneath the earth's crust. These aliens have begun preparations for a hostile takeover of the planet. Luckily for humanity, Jason really wants his frog back. Eventually Jason squares off with the mighty Plutonium Boss, leader of the Lightning Beings, and defeats him. The aliens, leaderless, scatter, and from afar, Jason watches as their world collapses upon them...watches with Sophia, and his frog.

But Jason's combat with the Lightning Beings was far from over. He learns that Sophia is actually a combat vehicle developed by another alien race trying to stop the parasitic exploits of the Lightning Beings. Teaming up with Eve, an alien Sophia pilot, Jason sallies forth to mop up the remaining Lightning Beings. Successful in combat, with the prospect of lasting peace before them, Jason and Eve marry, settle on Earth, and spawn. Their two children are Elfie and Roddy.

3.2 Prelude

Five years ago, Eve passed away. A couple of years later, Jason is killed in a ferocious attack by Lightning Beings. With the planet threatened by mysterious geologic phenomenon and natural disasters, Elfie and Roddy take up the legacy of their parents, and though young and with little experience, pledge to protect humanity from the evil machinations of the Lightning Beings. Sophia has been modified and rebuilt through the years, by both Jason and Elfie, and now exists as Sophia J-7. Elfie continues to develop new parts to upgrade Sophia's abilities. The story begins with Elfie sending Roddy in on a standard surveillance mission...

4.0 Interface

4.1 Gameplay

You play the game as Roddy, a sixteen year old boy at the helm of an awesome all-terrain combat vehicle, Sophia. You will pilot Sophia through a labyrinth of 3D rooms in search of clues to the enemy's movements. Occasionally you will encounter enemy installations or limiting topography that will force Roddy to leave Sophia, and advance on foot. As the game progresses, new equipment will be made available for Sophia, allowing access to new areas.

4.1.1 Environment

The game environment is divided into two areas; the overworld (underworld, actually,) and Gates. The overworld is large and can be traversed easily by Sophia, but also by Roddy, though with much greater difficulty. It is divided into five basic areas, Ground, Cave, Water, Plant, and Lava. Ground acts as a nexus between the other four areas.

Each area has a slightly different topography, and movement will be restrict accordingly. Within each area are small installations that can only be accessed by Roddy while on foot. These enemy bunkers consist of many rooms containing elevators, equipment, stored materials, and more.

4.1.2 Movement

BMBA is a third-person, 3D platformer. So, you can move in any direction, though must suffer various limitations depending on your circumstances. When piloting Sophia, pressing forward will move the vehicle forward, while pressing back will move Sophia in reverse. The speed at which this happens can be controlled with the analogue stick. Pressing left or right will turn Sophia in the corresponding direction. Sophia is also equipped with jump jets, and activating them will launch the vehicle into the air. The jets can also be activated to perform a side jump, and even a side jump while already in the air. Sophia's jump has a limited range, so many areas will be initially inaccessible. Water will also impede Sophia by slowing movement by about 50%. Equipment upgrade will eventually allow almost free movement, however.

Roddy has similar movement, though he will move (and therefore face) in whichever direction is pressed. He too can jump and side-jump, though his side-jump is more of a skip and cannot be performed while in the air, despite what the instruction manual says.

4.1.3 Navigation

Roddy's adventure will be guided through the use of a head's-up radar, and an auto-map. The radar appears in the lower right corner of the screen and displays an area around Sophia or Roddy larger than their field of view. It will show room boundaries, exits, and important features in a room such as switches. The exit you entered a room from will be marked with a yellow dot. Enemies appear as red dots. Special items (switches, etc.) appear as green dots until activated. The radar also has a compass to help orient you to the map.

The map is accessed on the sub-screen. Rooms will automatically be mapped when you enter them. Sophia and Roddy's positions will also be indicated, but only as to which room they are in, not where in the room. Gates and boss locations are recorded on the map, as well as any points of interest detected by Elfie. Garages (maintenance tunnels, i.e. save points) are not indicated on the map, as well as items or equipment that appear as green dots on the radar. Maps are kept for each area and will be shown only when you are in that area. The rooms on the map generally represent the shape of the actual rooms, but are sometimes simplified. A compass on the map screen shows which way Roddy or Sophia is facing.

4.1.4 Item Collection

There are many items scattered through the game, many in plain view, but most hidden in objects or dropped by enemies. Items appears as wire-frame pyramids with an icon floating inside. Drive or walk over the item to collect it. Its effect will be immediate.

4.1.5 Item List

The instruction manual lists all of the items in the game. The items can be divided into three types: healing, assault, and support.

Healing Items - Energy can be restored by collecting pyramids with glowing starbursts. The most common variety recover two units of health, the larger starburst will recover half of your maximum, and the blue starburst will fully revitalize.

Assault Items - These basically provide energy, or ammo to your weapons. Green pyramids with a B, H, T, or F will increase the power of Sophia's secondary attacks Blaster, Homing, Thunder, or Field Guard, respectively. Items with an X increase the power of the currently selected secondary. The Alpha item increases the power of all secondaries. While the Omega item will restore all secondary weapons to maximum power. Red triangles with Gun increase the level of Roddy's gun.

Support Items - These are rare items that perform various functions. Timer appears as a clock and stops enemies temporarily. Warp appears as a swirl and teleports you to an adjacent area. X Bomb appears as a red explosion and disintegrates enemies in the area. Critical Charger appears as twinkling stars. Collecting this item will max your action power (used for hover and boost) for a period of time.

Multi - The instruction manual refers to items labeled B-Memory, T-Memory, etc. These are actually the same item. When encountered, the item will pulsate, changing from B to M to T, etc. Since the item has multiple qualities, I have dubbed them "Multis." I have noted the location of multis in the walkthrough. Multis increase the maximum power of the secondary weapon indicated. It does not matter which secondary is active, or even if that secondary has been equipped. The maximum level for a secondary is 8.

4.2 Sophia

4.2.1 Controls

The controls are listed in the manual and the options menu, but I'll go through them quickly here.

Up-down - Moves Sophia forward or backwards

Left-right - Turns Sophia left or right

Select - Ejects Roddy

Start - Enter sub-screen (save menu in garage.) Pressing when the red light on the top of the life meter is flashing will answer a call from Elfie.

Square - Fire pulse cannon. Hold the button for continuous fire.

Sophia has mild tracking capabilities and will angle fire to hit enemies if they are within a narrow cone in front of Sophia.

X - Jump up. Jump while moving to jump in that direction.

Circle - Activates secondary weapon.

Triangle - Activates extra move (see upgrades.)

L1/R1 - Side jump. Press while jumping normally to jump in the air.

This technique (tacking) can be used to access some ledges not normally within jumping range.

L2/R2 - Rotate selection of secondary weapons.

While the default control settings are okay, later in the game you may find it difficult to hit all the buttons you want when you need them. It may be beneficial to move extra move or secondary weapon control to L2. This will free up enough fingers to allow you to jump left and right while hovering and attacking. The three-finger method makes it difficult to reach the R1 button without releasing the other buttons.

4.2.2 Upgrades

Throughout the game, usually after completing a mission, Elfie will send additional parts to a nearby garage to be equipped on Sophia. These parts will add power and maneuverability to Sophia.

Secondary Weapons - Sophia begins the game with one secondary; Blaster. Blaster fires a cluster of hyper shots that can blast through multiple targets. Upgrade Blaster by collecting multitis to increase its size and power. After Mission 1, Elfie will install three more attacks:

Homing Missiles - Press and hold circle to activate. Missiles will charge and will lock on targets in range. Release the button to fire. Missiles will track enemy movements, but are not exceptionally agile and will not always connect. Initially, Homing fires four missiles. Collect multitis to upgrade Homing to fire six missiles. Homing can lock on a single target multiple times, but will lock only as many times as required to destroy the target. Therefore, if trying to shoot down a jet that cannot survive one shot, Homing will only lock once, and the remaining shots will be wasted.

Thunder - A close range weapon that discharges a continuous blast of electrical energy. Press circle to activate. Thunder will remain active until circle is pressed again, Thunder energy is depleted, or you switch secondaries. Upgrade Thunder by collecting multitis to increase range of effect and amount of damage delivered.

Field Guard - A seemingly worthless ability...at first. Field Guard launches a drone that orbits Sophia. The drone does not damage enemies, nor does it block their shots. It does, however, destroy missiles and other similar projectiles. Upgrade by collecting multitis to add a second drone, increase their speed of movement, and eventually enable them to fire. Fully powered Field Guard triples your shots as well as providing additional defenses. Field Guard depletes energy slowly, further increasing its value.

When upgrading with multitis, always power up Blaster until the other secondaries have been installed. Then focus on Homing and Thunder, leveling them up together (though I give preference to Homing early.) Keep Blaster within one or two levels of Homing and Thunder. Ignore Field Guard for now. Homing becomes worthless later in the game, so max out Thunder and even Blaster before picking up the last couple of Homing multitis. Once Homing and Blaster are at least at level four, and Thunder is at six, start collecting Field Guard. Level Field Guard up until it can fire. Field Guard is only useful at that point, and really isn't needed until Mission 6 or so. If you are thorough in collecting multitis, you'll be able to max most weapons after obtaining Hover.

Climb - Obtained after Mission 2. Sophia's wheels transform into spike-ended spider legs. Activate by pressing triangle at locations indicated with a Climb icon. Sophia will then climb up between parallel rock

faces. At the top of the climb, press forward to move forward. A really cool looking function, but virtually unused in the game.

Submarine - Obtained after Mission 4. Transforms Sophia's into a submarine allowing free movement when underwater. Sophia will automatically transform when submersed, but in order to surface or swim above the ocean bottom, you must press triangle.

Boost - Obtained after Mission 5. Press triangle while moving to double Sophia's speed. Using Boost slowly depletes Sophia's auxiliary battery.

Key - Obtained after an event during Mission 6. The Key technically isn't an upgrade, nor is it an actual item in the game. But, it was in the first game, and since after the event you will have access to the sealed glyph-doors, I've labeled it as an upgrade.

Hover - Obtained after Mission 6. Pressing triangle while stationary or in the air will fire thrusters that lift Sophia vertically. While hovering you can mover in any horizontal direction. Hover quickly depletes Sophia's auxiliary battery. Use short controlled bursts to maximize range.

4.3 Roddy

4.3.1 Controls

The controls for Roddy are similar to Sophia's.

Up-down-left-right - Moves Roddy.

Select - Returns Roddy to Sophia if within range. Otherwise an arrow will appear over Roddy pointing towards Sophia.

Start - Enter sub-screen (save menu in garage)

Square - Fire gun cannon. Hold the button for continuous fire.

X - Jump up. Jump while moving to jump in that direction. Can also control movement while jumping.

Circle - Drops napalm which explodes in three plumes of fire after charging.

Triangle - Activates Hypersonic. Roddy will charge up, then frenetically streak around the screen, impervious to damage, inflicting heavy damage on anything he hits. Roddy will not be able to hypersonic again until his equipment has recharged. The level of charge is indicated by the amount of color of the helmet on the energy gage. When the helmet flashes, hypersonic can be activated.

L1/R1 - Side jump.

L2/R2 - Rotate camera 90 degrees.

4.3.2 Weapon Upgrades

Collecting Gun items will upgrade Roddy's gun, giving him greater range and power. Note that if Roddy sustains damage he will lose upgrades for each couple of units of health lost. Below I've listed and described each of the six levels. Note that the gun will always be at least level one.

Level 1: Default - Short range, weak energy pulses

Level 2: Long range energy bolts

Level 3: Long range energy whirls, expand as they fly

Level 4: Small exploding bolts; one explosion

Level 5: Large exploding bolts; multiple explosions

Level 6: Plasma torch; short range but devastating

5.0 Walkthrough

5.1 Intro

Watch the opening movie to get in the right mood, then press start like it says on the screen to access the main menu. Set any options you want prior to starting a new game since you cannot access the options during game play. Note that the game will auto-load settings only if a save file exists on the memory card in slot 1.

5.1.1 Options

Difficulty - Choose from Easy, Normal, and Hard. Changing the difficulty alters the speed, power, and durability of the enemies. It also changes the version of enemies present in a room. For example, a tunnel full of level 1 orange crabs on Normal may be full or purple level 2 crabs.

View - Choose from Up or Long. Boy, that's informative... As best I can tell, Up and Long describe where the camera is relative to Sophia. However, Long means it is further back from the vehicle providing greater peripheral view, while Up means the camera is right up near the vehicle. Up creates a camera angle more closely representative of what the field would look like from within Sophia, but it makes maneuvering much more difficult. Use this angle after you've played through the game and are looking for a renewed challenge.

Sound - Choose Stereo or Mono. gee...

Movie Test - Watch movies encountered during gameplay. See the Bonus section for more information.

Vibration - On or Off

Sound Effects Volume - set it to your liking

Background Music Volume - same thing

Key configuration - Shows the default control settings and allows you to swap most functions freely.

5.1.1 New Game

Select New Game to start a new game. If you've already saved a game, use continue to pick up where you left off. While you can save to either memory card, part of the save is a system file that the game tries to access at start-up, but it will only find it if it is on the memory card in slot 1. A movie sequence will get things started, then it's up to you to finish.

5.2 Mission 1 - Cave

5.2.1 Ground Map

LEGEND	NORTH
W - Warp	
G - Garage (save)	WEST --- EAST
* - Special	
+ - Boss	SOUTH
B - Barrier	
R - Red Door	
G - Green Door	

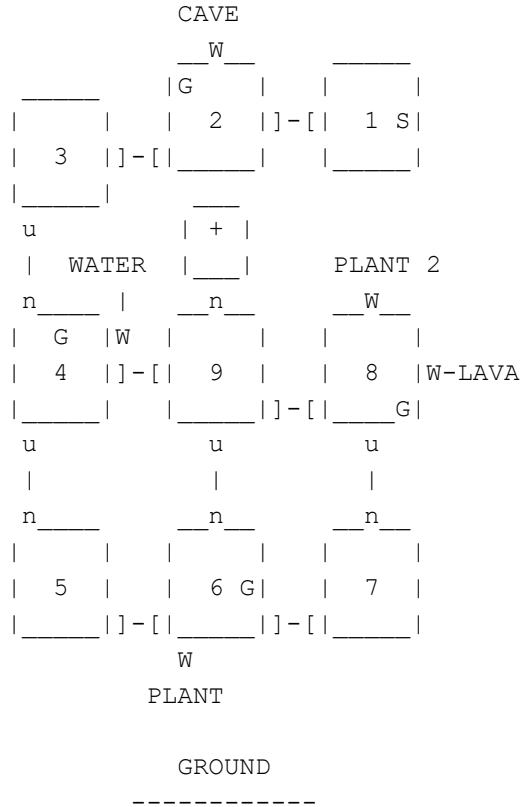

5.2.2 Ground

Room 1 - Enemies: 3 Whirligigs.

This is where you wind up after jumping into the crater. A pretty straight forward room to get you used to the controls and mild combat. The room is decorated with birds, geckos, and other animated critters that you can't interact with. The room is also populated with lots of rocks you can destroy. Rocks and other similar obstacles can be destroyed, sometimes revealing useful items. Exit to next room.

Room 2 - Enemies: 2 Flashlight Tank Generators, 1 Jet.

- Garage
- Warp to Cave

Take out the Jet and then play with the tanks. Once one is destroyed it will be replaced by the generator. Destroy the generators while they are activating. The garage is the platform surrounded by an energy fence. Hanging out in the garage will repair Sophia's armor. Pressing start will allow you to save. Anything that tries to attack you while in the garage will be destroyed by the energy fence. The tunnel opening with the colorful swirling lights is a warp that will take you to the next area. Warp to Cave.

Catacomb. Exit east (south end) to room 5.

Room 5 - Enemies: 3 Dual Turrets, 1 Missile Launcher

- Beacon

- Multi Power-up NW wall (cannot reach now)

This is a long room with north and south tiers divided by water.

Eliminate the Dual Turrets before tangling with the Missile Launcher.

Shoot the beacon on the east end of the north tier to deactivate the second (red) barrier. Exit east to Room 6.

Room 6 - Enemies: 2 Mantas

- Beacon

This long room is divided into three sections by high cliffs. Because of the geography you will be forced to circulate through the adjoining rooms to get to the other side. The two mantas are harmless if you stay out of the water. The Energy pistons are just decoration...sorry. Exit south (west side) to Room 7.

Room 7 - Enemies: 1 Hover Tank

Say hello to your first real (?) military challenge! Room 7 is a small arena complete with a big-ass opponent, and a nice viewing area along the east wall. This same ledge happens to be where you want to be, unfortunately you can't get there from the floor, and until you defeat the Hover Tank in glorious combat, the door leading to the path that will take you to that ledge is sealed. When you dispatch the tank, he will unlock the door for you, as well as leave behind an item to replenish your energy. Exit south to Room 8.

Room 8 - Enemies: 1 Tarantula, 4 Whirligigs

- Switch

A large cavern divided by a chasm. Shoot the switch to activate the bridge. Exit north (east side) to Room 7.

Room 7 - Stay on the ledge along the east wall and exit north to Room 6.

Room 6 - Do not fall off the west edge of the center section. Shoot the Beacon at the bottom of the east cliff to deactivate the third (green) barrier. Exit north to Room 9.

Room 9 - Enemies: 5 Crabs

- Gate Cave-1 (sealed by barriers)

You know that doorway with the flashing energy barriers that you keep seeing every time you shoot the red eyestalks? Ever wondered where the heck it was? It's in the NW corner of this room. But ignore it for now, since you can't get past the blue barrier that's still arcing across the opening. Btw, the barrier is the energy source Elfie detected. This room is a switch-back cavern, which may explain the Crab inhabitants who seem to like that sort of environment. Watch out for the trench with the purple radioactive goo. You will take damage as long as you are in it. Exit east to Room 10.

Room 10 - Enemies: 1 Tarantula, 2 Flashlights

- Beacon

The large energy pillars in this room are also just scenery (all you saboteurs are just going to have to wait.) Quickly dispatch the baddies and then ride the platform by the east wall up to the ledge. The easiest way to mount the platform is to stop underneath it and to jump up through it when it comes down. Otherwise you may roll off of it (no inertial dampers for Sophia.) Shoot the beacon in the SE corner to deactivate the final (blue) barrier. The barrier has been completely

shut down and the gate in Room 9 is now open. You could go back there now. But why do now what you can put off till later? Exit south to Room 6.

Room 6 - You've finally made it to the last section of the room! to reward you, the programmers have left a fossil of the second to last boss in the first game for you to look at. Falling off the ledge to the west will slow you down, so don't do it. Exit east to Room 11.

Room 11 - Enemies: None

- Garage

Pretty spooky, this pulsating, empty red room. Especially after seeing the fossilized remains of a level eight boss... Recharge your shields and save if you want, then exit east to Room 12.

Room 12 - Enemies: None

Large and empty, this cavern is filled only with floating platforms that you must jump between to get to the other side. You may notice what appears to be the ends of a bridge at the first platform. I'm not sure what the point is, as the first jump can be made without needing a bridge, but a bridge can be activated to help get you started. If you make it to the other side, you will find the east exit is locked. There is also a full energy, but you may wish to save it. At this point, the only reason for coming to this room is to fall off a platform. Fall and exit to Room 13.

Room 13 - Enemies: 2 Tarantulas, 6 Dual Turrets

- Switch

- Multi power-up (x2)

It's a trap! Take out the Tarantulas quickly while hugging a wall. The Turrets are mounted on the ledges bordering the room, so if you hug the walls you will cut off the angle of the turrets close to you, and stay out of range of the others. There are two multies in the center of the room, one of which you can't reach now. I suggest getting the B-up to increase the max of your current (only) special attack. If you pick it up for a different special, it isn't wasted though, as you will be credited when that special is unlocked later in the game. Hidden behind rocks in the NW corner is a switch for the bridge in Room 12. Activate it if you wish. Exit west to Room 14.

Room 14 - Enemies: None

This is a stepped tunnel that takes you back to Room 10 (one-way) and drops you off by the platform. Exit west to Room 10.

Room 10 - We've completed our tangent and may now continue with our mission. Exit west to Room 9.

Room 9 - Go to the Gate in the NW corner. Press select to beam out of your vehicle. Run around and kill the Crab with your pathetic pea-shooter or napalm if you haven't mashed it already with Sophia. Once you've run out of diversions, enter Gate Cave-1.

5.2.5 Cave Gate 1 Map

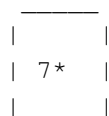

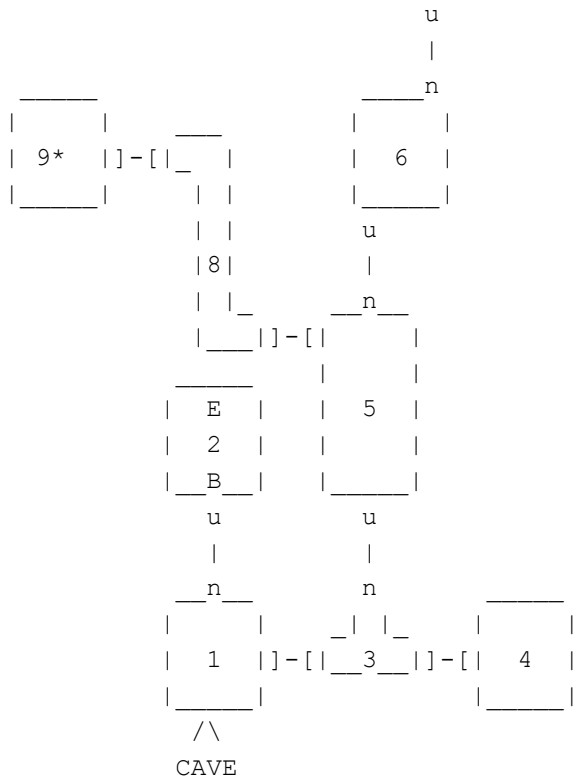

CAVE: GATE C-1 LEVEL 1

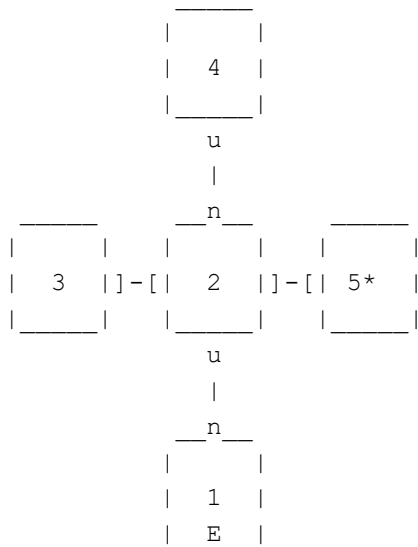

CAVE: GATE C-1 LEVEL 2

5.2.6 Cave Gate 1

Room 1 - Enemies: Evil Vincent Generator

You will start in the south end of a square room. An Evil Vincent is waiting to rough you up in the SE corner...hovering near a generator. Use this opportunity to acclimate to the different camera set up and controls. Soon you will have Gun upgrades, upgrades that you will lose when you take damage. I find that setting the camera such that it is behind Roddy when moving up on the screen provides the best visibility. The hardest part is remembering which button rotates the camera which

way when changing directions. Drop some napalms to finish off the generator. Elfie locates another energy source. Head there by exiting east to Room 3.

Room 3 - Enemies: 2 Evil Vincents

Yes, we've skipped Room 2. Going north from Room 1 will get you there, but beyond the door is a force field prohibiting further exploration. This walkthrough attempts to efficiently, albeit verbosely perhaps, walk through all areas of the game. So areas will only be discussed once unless you have to double back through them. The resulting order of progression does not necessarily match the order I mapped the rooms. Sorry. This corridor is easily cleared. The Vincents often drop Gun upgrades, so this room can be used to make Roddy a bit more of a threat. Exit west to Room 4.

Room 4 - Enemies: 4+/- Evil Vincents
- Gun upgrade (x5+/-)

The boxes in this store room surround a small compliment of Vincents. Carefully destroy a stack of boxes to get at the drones, being careful to avoid their fire. The boxes should contain enough gun upgrades to obtain the plasma torch. After stocking up exit back to Room 3.

Room 3 - Exit north to Room 5.

Room 5 - Enemies: 6+/- Bats

Elfie will inform you that the enemies are in control of the door. Destroy the Bats before they strip you of your arsenal. After clearing the room, exit north to Room 6.

Room 6 - Enemies: 1 Evil Vincent

The floor of this large room is covered with radioactive goo. Floating over it are several platforms. Hop along the moving platforms to the other side. If you fall, quickly jump onto the closest stationary platform. You can then jump to the nearest moving platform and continue on your way. The Vincent can get to you on the higher ground, so keep your eye on its movements. Exit north to Room 7.

Room 7 - Enemies: None
- Crystal

This room contains the object of your search. Collect the crystal to unlock half of the seal on the door in Cave Room 12. Collect any items you might want and exit to Room 6.

Room 6 - Exit south to Room 5.

Room 5 - Exit west to Room 8.

Room 8 - Enemies: 2 Spider Drones
- Gun upgrade

The retracting spikes in the floor of this room are the least of your worries. Take on the Spider Drones one at a time, moving in circles around them to avoid their fire. Drop napalm or go hypersonic to finish them off. Exit west to Room 9.

Room 9 - Enemies: None
- Console
- Gun upgrade

Earlier I mentioned a barrier in Room 2. Destroying the console in the center of this room will deactivate said barrier. Wreak havoc and exit to Room 8.

Room 8 - exit east to Room 5

Room 5 - exit south to Room 3

Room 3 - exit west to Room 1

Room 1 - exit north to Room 2

Room 2 - Enemies: None

- Elevator

Prior to destroying the console in Room 9, access to the elevator will be blocked by an energy field. Ride the elevator up to Level 2.

Level 2

Room 2-1 - Enemies: None

- Elevator

Exit north to Room 2-2.

Room 2-2 - Enemies: 4 Evil Vincents

Following the Left Hand Rule, exit west to Room 2-3.

Room 2-3 - Enemies: 8+/- Bats

- Gun upgrades (x2)

More annoying flying rats. They will sometimes drop gun upgrades as penance for hitting you. If that doesn't make recompense, blow up the equipment. Keep in mind though, there's no scientific evidence supporting the existence of catharsis. Exit to Room 2-2.

Room 2-2 - Exit north to Room 2-4.

Room 2-4 - Enemies: 2 Spider Drone Generators, 1 Evil Vincent

- Gun Upgrade

The one upgrade makes this room seem hardly worth it. Destroy the closest generator as quickly as possible. Do not let yourself get surrounded by drones. If you don't have the plasma torch, napalm will be your friend. Go hypersonic if you need to, that's what it's for. Exit to Room 2-2.

Room 2-2 - Finally, exit east to Room 2-5.

Room 2-5 - Enemies: None

- Crystal

Collect the crystal to unlock the remaining half of the seal on the door in Cave Room 12. Your work here is now through. Exit to Room 2-2.

Room 2-2 - Exit south to Room 2-1.

Room 2-1 - Take the elevator down to Level 1.

Level 1

Room 2 - Exit to Room 1.

Room 1 - Exit south to return to Cave.

5.2.7 Boss

Cave

Room 9 - Upon exiting the gate, Elfie will volunteer to zap you back to

Sophia. You can either accept her offer or hop in on your own. Once back safely inside Sophia (Roddy's health will recover when he returns to Sophia) exit east to Room 10.

Room 10 - Exit south to Room 6.

Room 6 - Exit east to Room 11.

Room 11 - Save and exit east to Room 12.

Room 12 - If you shot the switch in Room 13, the bridge to the first platform will be activated. Hop across the platforms to the now unlocked east exit. Exit to Room 15.

Room 15 - WARNING!!

Enjoy the cinema scene and prepare for the first boss. Refer to the boss section of the Enemy Compendium for details and strategy for defeating the Solar Mech Guardian. You will notice a series of bars in the upper right corner of the screen. These represent the power levels for the eighteen components that make up the Guardian. As you damage it, the bars representing the affected parts will diminish. Once a part's energy has been depleted it will no longer function, reducing the attack options available to the Guardian. Defeat the mech to watch another movie and be transported back to Ground Room 2.

5.3 Mission 2 - Water

5.3.1 Rewards

Following Elfie's instruction, pilot Sophia to the nearby "maintenance tunnel." Upon entering, the optional parts Elfie mentioned will be installed. By pressing the L/R2 buttons you will be able to scroll through three new secondary attacks, plus the Blater shot you already have. Each attack mode is represented by a different color, which might be easier to keep track of until you learn the graphic representation. At this point in the game, there really isn't much need for these optional attacks, so use them freely to practice for the later missions when proper execution of your specials will be critical.

5.3.2 Ground

Room 2 - Exit west to Room 3.

Room 3 - Enemies: 6 Face Cannons

Assorted rock ledges sprout from the shallow water filling this room. Take out the nearest cannons while dodging their fire, then snipe the rest from a distance. Exit south to Room 4.

Room 4 - Enemies: 3 Jets

- Garage
- Warp to Water

The warp will open when you enter the room. Take out the pesky Jets, save if you wish, and Warp to Water.

5.3.3 Water Map

Room 1 - exit north to Room 2.

Room 2 - Enemies: 5 Narwhales

This room is a bend in a deep river. The north exit is out of reach due to the depth of the water. Be wary of the school of Narwhales circling in the water. Dive in and hop around to the east exit. Exit east to Room 3.

Room 3 - Enemies: 4 Mines, 2 Tarantulas

The water wraps around a stepped land mass. On your way out of the water, don't get too close to the floating mines. Detonate them harmlessly from a distance, or even better, lure the Tarantulas into the blast radius of a mine before detonating the mine. The pistons at the top of the rock formation are decorative. Exit east to Room 4.

Room 4 - Enemies: None

- Beacon
- Multi out of reach on north wall
- Multi in water above south exit

This large cavern contains a lake bordered between two high cliffs. Originally, the water level is low. By triggering the switch in Room 6, however, the water level will rise to match the cliffs and enable passage to the east exit via the floating icebergs. Watch your shadow when jumping and brake when landing, but brake gently so as not to go into reverse. Collect the multi on the south wall. Having fallen into the water, exit south to Room 5.

Room 5 - Enemies: None

A stepped cavern that will be submerged if you triggered the switch in Room 6. Exit west to Room 6.

Room 6 - Loop back to Room 4 as instructed above.

Room 4 - This time, cross to the other side and shoot the beacon to deactivate the green barrier in front of Gate W1. Exit east to Room 8.

Room 8 - Enemies: 4 Mines

The steps north along the west wall lead to the exit to Room 9. The remainder of the room consists of high ledges separated by deep water. Hop across the floating platforms to get from ledge to ledge. Note that the platforms that don't pulsate will drop shortly after you land on them. Exit north to Room 9.

Room 9 - Enemies: None

- Garage

Recharge and save. Exit south to Room 8.

Room 8 - Exit southeast to Room 10.

Room 10 - Enemies: 6 Crabs

- Beacon

These catacombs have floors between the branch tunnels that will collapse after you drive on them. The pits they reveal contain radioactive goo that will damage you if you wallow in it. Shoot the beacon to deactivate the second barrier (blue) in front of Gate W1. Exit south to Room 11.

Room 11 - Enemies: 4 Jets

- Gate W1 (SE) - Deactivate barriers in Rooms 4 and 10

- Gate W3 (SW) - Deactivate barrier in Gate W2

The sides of this cavern are terraced with rivers flowing to the center from both the east and west walls. The rivers empty into a hole in the middle of the room. Falling in will take you to Room 12. Exit SE to Gate W1.

5.3.5 Water Gate 1 Map

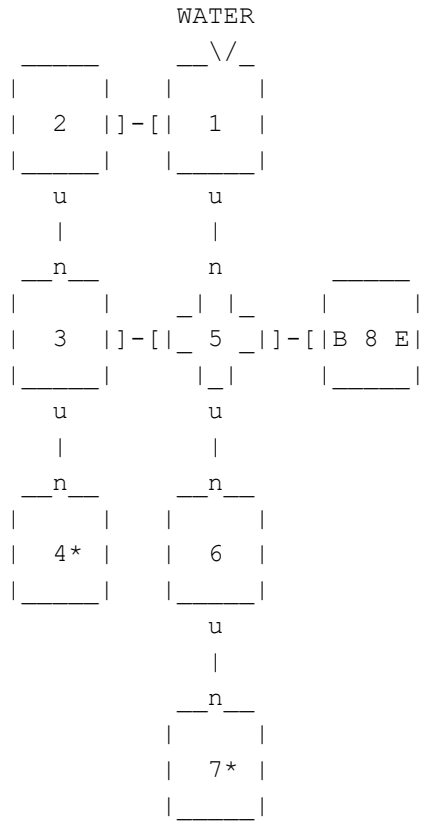

WATER: GATE W-1 LEVEL 1

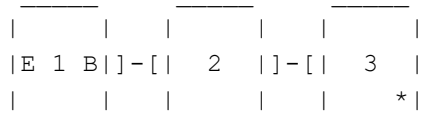

WATER: GATE W-1 LEVEL 2

5.3.6 Water Gate 1

Room 1 - Enemies: 2 Evil Vincent Generators (mkII)

The generators will each produce 2 Vincents at a time. Don't allow the population to grow too much if you want to try to get guns from these guys. Exit west to Room 2.

Room 2 - Enemies: 3 Spider Drones

- Gun upgrade

The boxes in this storeroom will help you isolate the Drones so you aren't fighting them all at once, but they will restrict your movement. exit south to Room 3.

Room 3 - Enemies: 8 Bats

The floor of this room is covered with radioactive ooze. Stay on the catwalks while trying not to get hit by the bats. Exit south to Room 4.

Room 4 - Enemies: None

- Console

Destroy the console to shut down the barrier blocking access to the elevator in Room 8. Exit north to Room 3.

Room 3 - exit east to Room 5.

Room 5 - Enemies: 2 Evil Vincents

The east branch of this four-way corridor is guarded by an intermittent laser barrier. The timing isn't very difficult. Exit south to Room 6.

Room 6 - Enemies: 8 Bats

Similar to Room 3, but the catwalks here are over water, so feel free to dive in to dodge the damn bats if needed. Exit south to Room 7.

Room 7 - Enemies: None

- Console

Destroy the console to deactivate the barrier blocking the elevator on level 2. Exit north to Room 6.

Room 6 - Exit north to Room 5.

Room 5 - Exit east to Room 8.

Room 8 - Enemies: None

- Elevator

Access to the elevator will be blocked by a barrier if you failed to destroy the console in Room 4. Ride the elevator down to Level 2.

Level 2

Room 2-1 - Enemies: None

- Elevator

Access to Room 2 will be denied if you failed to destroy the console in Room 7. If you took it out, exit east to Room 2-2.

Room 2-2 - Enemies: 5 Spider Drones (2 are mkII)

Destroy the enemies to continue. If you can't pick them off before being targeted, use your hypersonic strategically to take out multiples. Exit east to Room 2-3.

Room 2-3 - Enemies: None

- Switch

- Gun upgrade

Destroy the boxes to find the gun upgrade if needed. Shoot the hemispherical switch to deactivate the barrier guarding Gate W2. Exit Gate W2.

[2-3 west to 2-2, west to 2-1, elevator to level 1. 8 west to 5, north to 1, north to Water]

5.3.7 Water cont.

Room 11 - Jump in the hole and exit to Room 12.

Room 12 - Enemies: None
- Multi

The current in this tunnel is strong and you won't be able to go upstream to get the multi and exit south until you have the submarine upgrade. Exit west to Room 13.

Room 13 - Enemies: 7 Fireplants
- Multi (x2)

This is a deep room. To climb out you'll have to scale the ledges circling the room. In the southeast corner of the floor, disguised as a small rock, is the first multi. Use Thunder or Roddy's napalm to uncover it. Floating high over the center of the room, opposite the north exit is a multi. Jump down to get it. Exit north to Room 7.

Room 7 - Exit west to Room 1 and loop to Room 8 as outlined above.

Room 8 - Visit the garage in Room 9 if you need to and then exit NE to Room 14.

Room 14 - Enemies: None
Empty tunnel. Exit north to Room 15.

Room 15 - Enemies: 3 Whirligigs, 2 Missile Launchers
- Gate W2 - Deactivate barrier in Gate W1

Progress carefully through the open terrain of this room, taking out the missile launchers from long range. Exit north to Gate W2.

5.3.8 Water Gate 2 Map

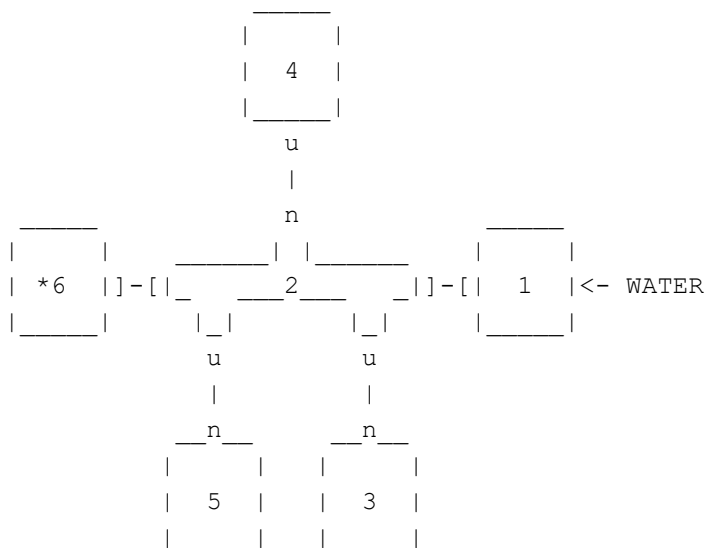

WATER: GATE W-2

5.3.9 Water Gate 2

Room 1 - Enemies: 8 Bats
- Multi
- Gun upgrade

Large cross-shaped room with radioactive goo on the floor. Cross on the gantries and nuke the annoying bats. The multi is found on the east side of the south branch. The gun can be found at the end of the north branch. Exit west to Room 2.

Room 2 - Enemies: 4 Dust Pans, 3 Fire Pods.
This long corridor is well stocked with bad guys. Move quickly to avoid enemy fire and carve a path to the first branch. Exit south to Room 3.

Room 3 - Enemies: None
- Gun upgrade (x2)
Loot this storeroom to increase your firepower. Exit to Room 2.

Room 2 - Napalm the Fire Pods and blast your way through to the next branch. Exit north to Room 4.

Room 4 - Enemies: None
- Gun upgrade
There's not as much booty in this room, but it may come in handy. Exit south to Room 2.

Room 2 - Blast your way to the next branch. Exit south to Room 5.

Room 5 - Enemies: None
Not much here but a bunch of boxes and...well, you. Exit north to Room 2.

Room 2 - Finally, exit west to Room 6.

Room 6 - Enemies: None
- Switch
- Gun upgrade
In the back of this storeroom is another floating hemisphere. Shoot it to deactivate the barrier shielding Gate W3. Exit east to Room 2.

Room 2 - charge through and exit east to Room 1.

Room 1 - exit east to return to Water Room 15.

5.3.10 Water cont. some more

Room 15 - Hop on your ride and exit south to Room 14.

Room 14 - exit west to Room 8.

Room 8 - exit SE to Room 10.

Room 10 - exit south to Room 11.

Room 11 - Hop over to the SW corner and enter Gate W3.

5.3.11 Water Gate 3 Map

```
| 2 | | 1 |  
| + | ]-[ | G | <- WATER  
|_____| |_____|
```

WATER: GATE W-3

5.3.12 Water Gate 3

Room 1 - Enemies: none

A pint size garage awaits you in the middle of this room. Guess you know what's coming. Save and exit west to Room 2.

Room 2 - WARNING

While there is no movie this time, there is an entertaining bit of dialogue between Roddy and the Liquidator. Refer to the Boss section for detailed description and strategy. If you win this battle, duck, or you may end up needing to take a shower before getting back in your ride. A movie will follow and you'll be teleported back to Ground 4.

5.4 Mission 3 - Plant

5.4.1 Rewards

Elfie agrees that Sophia is under-equipped and sends some more optional parts to the nearby maintenance tunnel. Park Sophia to have the upgrade installed. You've now acquired the cool but nearly useless Climb function. Pressing triangle at designated locations (the word CLIMB! will appear between two parallel rock faces) will transform your wheel base into four spiked legs. Sophia will climb up between the columns by embedding the spikes in the walls. Sophia can then scale horizontally between the faces by pressing forward on the controller. Releasing the triangle button will disengage the climb function and Sophia will drop to the ground. Also climbing horizontally beyond the extent of the cliff will automatically disengage climb, but Sophia will simply stop climbing when you reach the top of a cliff when climbing up. Climb cannot be used anywhere to drive up vertical surfaces as in the original game. Sorry.

5.4.2 Ground

Room 4 - Exit south to Room 5

Room 5 - Enemies: 6 Fireplants
- Multi

This multileveled cavern has two ledges that are accessible only by using Climb. The first climbing opportunity is directly in front of you when you enter the room. Drive in between the two stone columns. The appearance of the word climb will indicate when you are properly positioned. Climb to the other side to get the multi. Cross back to the north side by whichever means is most entertaining and climb along the east wall to get to the east exit. Exit east to Room 6.

will make dodging enemies more difficult and create many blind jumps that could land you in streams of radioactive goo. Also, the aggressiveness of the enemies increases notably. Locate the two pods marked with the insignia of Roddy's mother's pendant, and shoot them to activate. Exit north to Room 2.

Room 2 - Enemies: None

Take the north branch of this tunnel. Exit north to Room 3.

Room 3 - Enemies: 6 Crabs (2 Purple)

- Pod

Clear out this small room and activate the Pod. exit south to Room 2.

Room 2 - Exit west to Room 4.

Room 4 - Enemies: 3 Fireplants, 2 Tarantulas

- Pod

- Gate P1

A river of goo runs through this chamber. Be careful of rock ledges that will collapse under Sophia's weight. Activate the Pod. In the spirit of completeness, enter Gate P1.

5.4.5 Plant Gate 1 Map

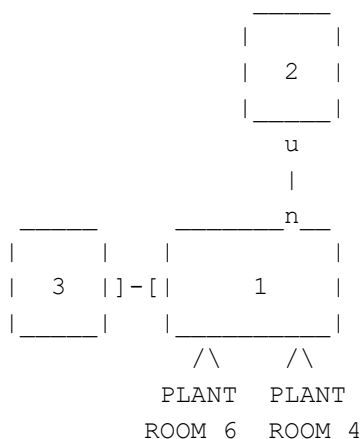

PLANT: GATE P-1

5.4.6 Plant Gate 1

Room 1 - Enemies: 6 Bats, 2 Lava Imps

This is a large room with a floor of radioactive goo. There are two exits along the south wall, both of which exit back to Plant. The west exit leads to Plant Room 5, while the east exit will take you back to Plant Room 4. Running along the catwalks you'll pass spots in the goo occupied by Lava Imps who will pop up and hurl an Energy Crescent at you. It's not worth the time and gun upgrades to fight it out with the Imps. Keep moving and jump to shake the persistent crescents that will follow you at length. Exit north to Room 2.

Room 2 - Enemies: 6 Bats

- Gun upgrade

Clearing out this storeroom will net you a gun upgrade, assuming you can clear out the bats without getting hit too much. Exit south to Room 1.

Room 1 - Exit west to Room 3.

Room 3 - Enemies: None

- Gun Upgrade (x2)

This equipment room has two upgrades. Exit east to Room 1.

Room 1 - Exit SE to Plant Room 4.

5.4.7 Plant cont.

Room 4 - Okay, that was an exciting detour. Exit west to Room 5.

Room 5 - Enemies: 8 Crabs

- Gate P1

These catacombs contain a second entrance to Gate P1. Continue west and exit south to Room 6.

Room 6 - Enemies: 6 Narwhales

- Pod

A large body of water separates the east bank from the outcropping around the west exit. A Roddy-sized bridge crosses the water, which means Roddy will have to disembark to see the other side. The west exit is closed, however, and can be opened via the pressure trigger in Room 1. The water is deep and has a strong current that will sweep you out of the room to the south. Shoot the Pod then jump into the water. Exit via the current to Room 7.

Room 7 - Enemies: None

- Multi

The current will deposit you in a peaceful, bird-filled cavern with an inaccessible ledge. Exit south to Room 8

Room 8 - Enemies: 3 Crabs

A simple tunnel. Exit east to Room 9.

Room 9 - Enemies: 3 Guardians

- Pod

- Gate P2

- Multi

This is a dangerous room, and Elfie will even tell you so. Stay on the ledge you enter the room on. The three Guardians that guard the floor below are fast and have enough combined firepower to seriously put the hurtin' on you and your wonder-bug. Staying on the ledge will allow you to snipe them with Homing Missiles to soften them up while staying out of their range. If you've been applying multis to Homing you should have sufficient ammo to take out at least one. Drop down to finish off the remaining opposition with Thunder and Hyper. You will be awarded a multi if you destroy all three Guardians. Activate the Pod at the south end. The west exit is too high to reach from the ground. Exit to Gate P2.

5.4.8 Plant Gate 2 Map

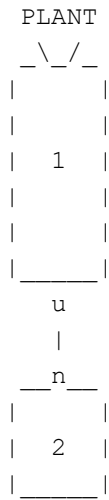

PLANT: GATE P-2

5.4.9 Plant Gate 2

Room 1 - Enemies: 6-8 Bats

This is a large open room. Exit south to Room 2.

Room 2 - Enemies: 2 Draconians

- Multi

Well, this is it...all there is to Gate P2. Get the Draconians to chase you and then run in circles continuously dropping napalm till they die. Collect your multi. Exit north to Room 1.

Room 1 - Exit north to Plant

5.4.10 Plant cont. some more

Room 9 - Exit north to Room 10.

Room 10 - Enemies: 6 Crabs

The crabs infesting these catacombs are mostly (if not all) purple. While a couple of hyper blasts will plow the row easily, you'll be coming back through here on foot, so take note of the tactics used by these nastier aggressors. Exit SE to Room 11.

Room 11 - Enemies: 4 Tarantulas, 1 Dual Launcher

- Pod (x2)

The Tarantulas like to attack in pairs. The blast from taking one out will damage any others in close proximity (including you.) The Dual Launcher unloads an insane amount of ammo on you, so make sure there aren't any other bad guys you're trying to out maneuver when you take it on. Make use of what cover is available to you and strike hard. The east exit can only be accessed by Roddy on foot. Shoot the two Pods. Exit south to Room 12.

Room 12 - Enemies: 8 Face Cannons

- Pod

This room is thoughtfully stocked with plenty of enemies and radioactive

goo. Take down the cannons at long range, and watch your step crossing to the south side. Shoot the Pod. If you haven't missed any Pods, activating the one in this room will trigger a cut-scene which unveils Gate P3. Exit east to Room 13.

Room 13 - Enemies: 6 Crabs

Blast your way through the tunnel. Exit north to Room 1.

Room 1 - Eliminate any flying pests that annoy you and seek out the Pressure Trigger in the SW part of the room. Park Sophia on it to open the door blocking the west exit in Room 6. Exit Sophia and hop up to the west exit. Exit west to Room 11.

Room 11 - Two Tarantulas will attack you as soon as you enter the room. If you stay in the tunnel you start in they can't get you, but neither can you get them. If you get boxed in you'll have to wait until one jumps and make your break for it. Jump while moving to dodge enemy fire and exit north to Room 10.

Room 10 - You'll quickly be mobbed by the Crabs. Jump, fire, napalm, and work your way around to the north exit. If you get surrounded, go Hypersonic, that's what it's for. Exit north to Room 6.

Room 6 - you can relax now, at least for one room. Cross the bridge to the west bank. If you're using the Dual Shock controller and worried about accidentally falling off, turn the analog off momentarily to walk a straight path. Exit west to Room 14.

Room 14 - Enemies: None

- Garage

Restore your health and save. Exit west to Room 15.

Room 15 - Enemies: 6 Crabs

- Gate P3

The west wall was what was shown in the cut scene when the last Pod was activated. Eliminate the Crabs in the immediate vicinity. The easy way to the Gate is to circle counter-clockwise along the walls. Heading north you can squeeze behind a tree and then head west, unmolested, to a cliff. Ride the floating platform over the ooze to get to the Gate entrance. Exit to Gate P3.

5.4.11 Plant Gate 3 Map

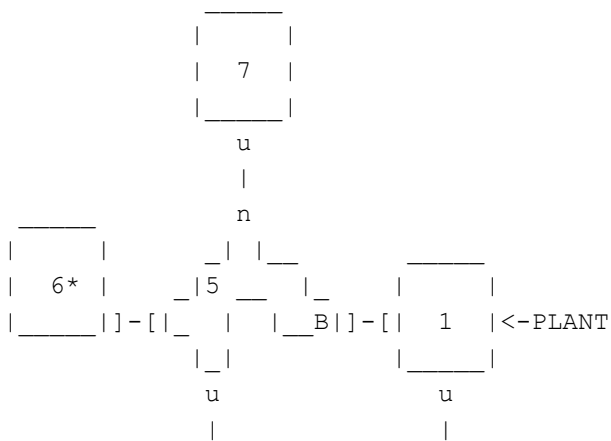

```

|      |      n      n
|  4*  |      _| |      | | |
|_____||- [|_ |_____| |
|          |3_____||- [|_____ 2|
|          |          |
|          |B|
|          |
|          |u
|          |
|          |n
|          |_____|
|          | 8 |
|          | G |
|          |_____|
|          |u
|          |
|          |n
|          | 9 |
|          |+_ |

```

PLANT: GATE P-3

5.4.12 Plant Gate 3

Room 1 - Enemies: 2 Evil Vincent Generators (mk I and II)
 Typical first room. Exit south to Room 2.

Room 2 - Enemies: 5 Spider Drones
 This long corridor is stocked with lots of Drones. The first few will be waiting for you when you enter. The remaining are stationed down the west branch and will engage with fervor once they've locked on to you. The south exit is blocked by a purple barrier. The west branch is divided by three sets of retracting floor spikes. Be careful attacking the Drones between the spikes. Exit west to Room 3.

Room 3 - Enemies: 2 Spider Drones (mk II)
 This corridor bends north. Eliminate or skirt the Drones and exit west to Room 4.

Room 4 - Enemies: None
 - Console
 Destroy the console to deactivate the barrier (blue) blocking the east exit of Room 5. Exit east to Room 3.

Room 3 - Exit north to Room 5.

Room 5 - Enemies: 5 Evil Vincents
 This corridor loops back to Room 1. The east exit will be blocked by a barrier (blue) if you failed to destroy the console in Room 4. Exit west to Room 6.

Room 6 - Enemies: None
 - Console
 Destroy the console to deactivate the barrier (purple) blocking the south exit of Room 2. Exit east to Room 5.

Room 5 - Exit north to Room 7.

Room 7 - Enemies: None

Uh...nothing here. Blow up the equipment to make yourself feel better.
Exit south to Room 5.

Room 5 - Exit east to Room 1.

Room 1 - Exit south to Room 2.

Room 2 - Exit south to Room 8.

Room 8 - Enemies: None

- Mini-Garage

Save now, 'cause you know what's next... Exit south to Room 9.

Room 9 - WARNING!

You enter a large, empty room. It's the boss room for level 3. Your opponent...the LEVEL THREE BOSS! [round of applause to the programmers for bringing back a boss from the first game...and having it preside over the same level (numerically) as the first game!] The Blocks will materialize one at a time. After a moment of activity they will stop, turn dark, and become untouchable. They pose no threat in this latent state, but can revitalize at any time. Try to take out each Block as it phases in. If all fifteen are in the room at once, it's going to be a tough fight. For veterans of the first game you will be pleased that the Block attacks have been jazzed up, but they aren't as difficult as the first game. The key to this fight, as always, is having the maximum gun upgrade. Refer to the Boss section for more in depth strategy. After cleaning up, a warp will open. Walk in to be teleported back to Sophia back on Ground and to see a movie that seemingly lacks context.

5.5 Mission 4 - Lava

5.5.1 Rewards

So, after defeating another boss and being warped back to Ground next to a Garage, you're probably excited to see what new mod Elfie will send you for Sophia. Well, you're going to have to wait, because all you get for your hard work on the last mission is the ability to do the next mission. Don't grumble too loudly...

5.5.2 Ground

Room 6 - You will appear adjacent to the garage. Exit east to Room 7.

Room 7 - Enemies: 8 Fireplants

You must cross a large expanse of lava to get to the exit to the next room. Take out the plants as you go and try not to spend too much time in the lava. The molten rock melts your tires pretty quickly. Exit north to Room 8.

Room 8 - Enemies: 3 Jets

- Garage

- Warp to Lava

- Warp to Plant 2

When you enter the warp to Lava will be opened. The west exit is accessible, but you have to tack your jump. For now, warp to Lava.

5.5.3 Lava Map

reach in the center of the room. Exit north to Room 3.

Room 3 - Enemies: 6+/- Crabs (2.0)

- Key sealed exit (north)

The tunnel is packed with some crabs, a pack you will start amidst. Blast your way through. The north exit is sealed until you acquire the Key. Exit west to Room 4.

Room 4 - Enemies: 4 Flashlight Tanks (2.0), 2 Whirligigs

This is an open room with lava and destructible vent stacks. Exit west to Room 5.

Room 5 - Enemies: 3 Hover Tanks

While this room appears as a tunnel on the map, it opens to a long narrow room with three large opponents. You should be able to take them out one at a time and move on without too much difficulty. Exit north to Room 6.

Room 6 - Enemies: None

Falling from the hole at when entering this room will drop you into the cavern below. You will land on an island in the middle of a lake of lava. Note there are large flares erupting from the lava. Contact with these flares will damage Sophia. In the center of the island is a pressure switch. Park Sophia on it to activate the south set of floating platforms. The three platforms will move towards the south exit and then return to the island. You have been conditioned from your experience on the Plant stage that you should exit Sophia and guide Roddy across the platforms to the exit. However, you can take Sophia with you. To do so, wait until the platforms have spaced themselves out about equally and side jump onto the first platform. When Sophia leaves the switch the platforms will stop moving. If you time it properly you can side jump to the last platform and then jump normally to the ledge at the exit. This room serves as a nexus to this level and you will return to it frequently. Since Elfie can teleport Roddy back to Sophia from anywhere in the level, and you will be returning, I suggest taking Roddy alone. Exit south to Room 7.

Room 7 - Enemies: 6 Flashlight Tanks (2.0)

- Gate Lava 1

This open cavern has many floating footbridges and Flashlight Tanks. Remember, the tanks will shoot over Roddy's head. The gate entrance is along the south wall, but ignore it for now. Exit south (west side) to Room 8.

Room 8 - Enemies: None (unless you count the 4 big, pissed off boulders)

- Multi

A multi, ripe for the picking, sits on the middle of a platform surrounded by vent stacks and lava. Oh, and to get to it you have to run around a small ledge...a small ledge occupied by four large, flaming boulders rolling around on it. The rocks are slow, so following behind one is easy enough, just be careful not to run into it, as the damage received is severe. Collect the multi, then exit north to Room 7.

Room 7 - Enter Gate L1.

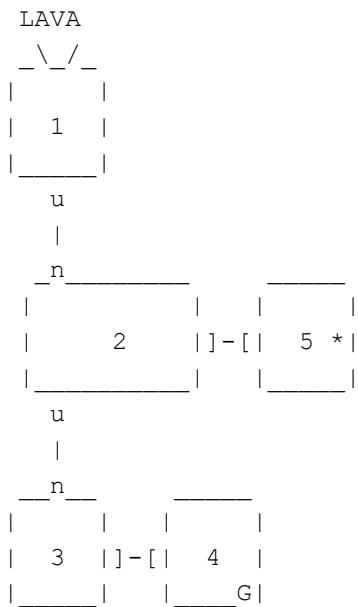

LAVA: GATE L-1

5.5.6 Lava Gate 1

Room 1 - Enemies: 4 Spider Drones (2.0 x2)
 - Gun upgrade

This large storeroom breaks up the monotony of the typical first rooms.
 Exit south to Room 2.

Room 2 - Enemies: None

The floor of this room is covered with lava, except for the ledges on
 the east and west sides. Currently, there is no way to access the other
 side. Exit south to Room 3.

Room 3 - Enemies: 5+/- Bats, 3 Lava Imps

This room too is filled with lava, but a catwalk provides access to the
 other side. The Lava Imps are not worth the hassle of combat. Take
 them out if you must, but you'll retain more gun upgrades if you run
 through. Exit east to Room 4.

Room 4 - Enemies: 5 Evil Vincents (2.0)

- Gun upgrade (x2)
- Mini-garage

Clear the enemies from this storeroom to proceed. Save if you want, then
 exit west to Room 3.

Room 3 - Exit north to Room 2.

Room 2 - Having defeated the drones in Room 4, floating platforms will
 now appear over the lava to provide passage to the east exit. Hop to
 the moving platform, then jump to the stationary platform in the center
 as you near it. Jump to the next platform as it moves in range. Exit
 west to Room 5.

Room 5 - Enemies: 2 Draconians

- Equipment

The adversaries in this room are far less threatening than their
 appearance. Once they've been dealt with, destroy the large piece of

equipment along the east wall. Doing so will change the platforms activated by the switch in Lava Room 6. Exit west to Room 2.

Room 2 - Exit north to Room 1.

Room 1 - Exit north to Lava Room 7.

5.5.7 Lava cont.

Room 7 - If you brought Sophia, hop in and exit to north to Room 6. If you brought Roddy on foot, press start and have Elfie transport you back to Sophia.

Room 6 - If you are in Sophia you are about to understand the benefit of taking Roddy on these side ventures. The equipment you destroyed in Gate L1 changes the platforms activated by the switch. The platforms that lead to the south exit have now recoiled at the center island and will remain forever stationary. To return to the center you will be forced to trop through the lava. Don't try to jump through the lava flares. Once you have returned to the switch (done automatically if you took Roddy solo) activate the switch and move across the platforms to the east as either Roddy (preferred) or with Sophia. Exit east to Room 9.

Room 9 - Enemies: 3 Jets.
- Gate L2

This long room is filled with ledges, floating platforms, and lots of lava. I suggest taking down at least two of the Jets before questing to the other side. Roddy can accomplish this task using hypersonic while jumping. Follow whichever path you are most comfortable with to the east wall. Note that platforms without blinking red lights will fall when you jump on them. Enter Gate L2.

5.5.8 Lava Gate 2 Map

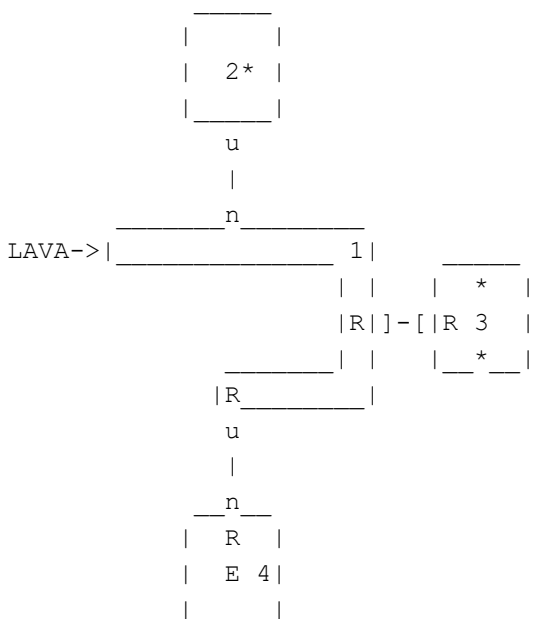

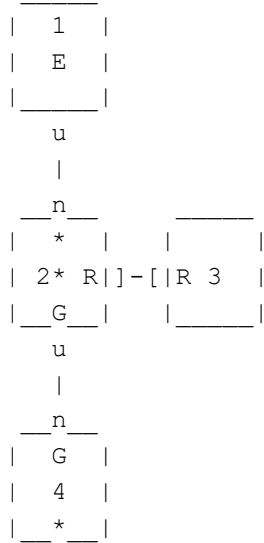

LAVA: GATE L-2 LEVEL 2

5.5.9 Lava Gate 2

Room 1 - Enemies: 4 Evil Vincents (3.0 x 2)

This long corridor also breaks from the traditional first room. Exit north to Room 2.

Room 2 - Enemies: None

- Red Switch

Jump on the platform in the center of this spacious room to activate it.

It will glow red indicating that doors with red thresholds will now be accessible. Exit south to Room 1.

Room 1 - Exit east to room 3.

Room 3 - Enemies: None

- Red Switch

- Green Switch

- Gun Upgrade

The gun upgrade over the green switch is bait. Collecting it activates the switch which will prevent you from leaving the room. Activate the red switch once more to open your way. Exit west to Room 1.

Room 1 - Exit south to Room 4.

Room 4 - Enemies: None

- Elevator

Ride the elevator to Level 2 Room 1.

Level 2

Room 2-1 - Enemies: None

- Elevator

Exit south to Room 2-2.

Room 2-2 - Enemies: 5 Evil Vincents (2.0)
- Red Switch
- Green Switch

The east exit is a red door. Verify the red switch is activated, then exit east to Room 2-3.

Room 2-3 - Enemies: None

-

This is a storeroom. Exit west to Room 2-2.

Room 2-2 - Activate the Green switch and exit south to Room 2-4.

Room 2-4 - Enemies: 8+/- Bats
- Equipment

Take out the damn bats and then destroy the equipment. The next set of platforms in Lava Room 6 will be activated. Exit north to Room 2-2.

Room 2-2 - Activate the Red switch or you will be coming back. Exit north to Room 2-1.

Room 2-1 - Ride the elevator to Level 1.

Level 1

Room 4 - Exit north to Room 1.

Room 1 - Exit west to return to Lava.

5.5.10 Lava cont.

Room 9 - Exit west to Room 6 is you brought Sophia, or teleport back with Elfie's help.

Room 6 - You should know the drill by now, though on this venture I suggest bringing Sophia. The opposition will be a little harder to eliminate or run from. Exit west to Room 10.

Room 10 - Enemies: 3 Bombers, 4 Flashlight Tanks (2.0)
- 3 Bridge Switches
- Garage
- Gate L3

Progress through the room by activating bridges over the various chasms. A full energy item is located just north of the east entrance under a platform just above the lava. It's there if you need it. Save and enter Gate L3.

5.5.11 Lava Gate 3 Map

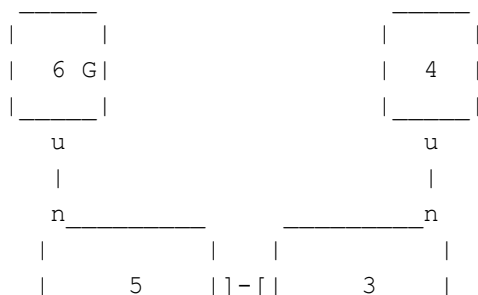

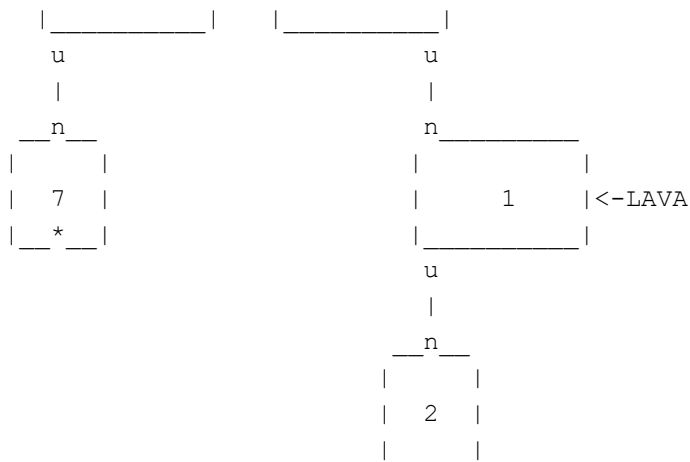

LAVA: GATE L-3

5.5.12 Lava Gate 3

Room 1 - Enemies: None

This is another lava/floating platform room. And certainly not the last. The platforms move diagonally towards the center. You will need to make your jump to the oncoming platform before they change direction or you'll wind up in the lava. Exit south to Room 2.

Room 2 - Enemies: 2 Draconians

- Gun Upgrade

Just a storeroom. Exit north to Room 1.

Room 1 - Exit north to Room 3.

Room 3 - Enemies: None

Another lava/platform room. As eager as you are to cross, don't. Exit north to Room 4.

Room 4 - Enemies: 3 Spider Drones (2.0)

- Gun Upgrade

Another storeroom. Exit south to Room 3.

Room 3 - There are three stationary platforms in the center of the room. Note that only the center one is flashing, the other two will fall. Two moving platforms circle in opposing quadrants of the room. Jump onto the nearest one (which circles quickly) and then jump to the center stationary platform (ignoring the non-blinky ones.) Jump onto the slow-circling platform and exit west to Room 5.

Room 5 - Enemies: None

Another lava/platform room. Will they ever end?! Actually, this is the last one. Unfortunately you'll have to pass through them all again to get out. Jump on the slow circling platform and it will take you all the way to the other side. Exit north to Room 6.

Room 6 - Enemies: 3 Spider Drones (2.0)

- Mini-garage

- Gun Upgrade

Clean out this storeroom and save. Exit south to Room 5.

Room 5 - Exit south to Room 7.

Room 7 - 3 Evil Vincents (4.0)
- Equipment

Destroy the equipment in this room to deactivate the platform in Lava Room 6 and activate the bridge. Exit north to Room 5.

Room 5 - Exit east to Room 3.

Room 3 - Exit south to Room 1.

Room 1 - Exit east to return to Lava.

5.5.13 Lava cont.

Room 10 - Save and exit east to Room 6 (or teleport if on foot.)

Room 6 - Drive north across the bridge. Exit north to Room 11.

Room 11 - Enemies: 6 Fireplants (2.0)
- Gate L4

This tall room consists of several small ledges suspended over a pool of flaring lava. The west exit is sealed. Work your way up the ledges on the north wall. There is a floating platform about half-way up that is obscured from sight by a ledge between it and the camera. You can try to side jump, but be careful lest you squirt between the platform and the next ledge and fall into the lava. Once you've obtained the summit, exit to Gate L4.

5.5.14 Lava Gate 4 Map

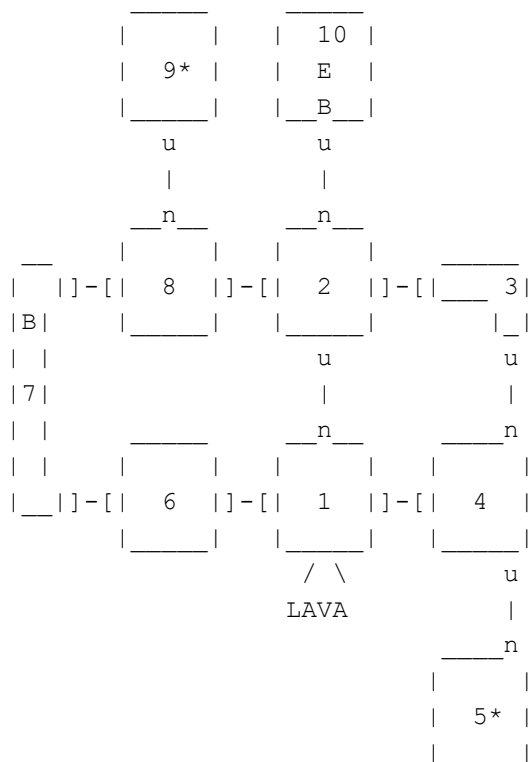

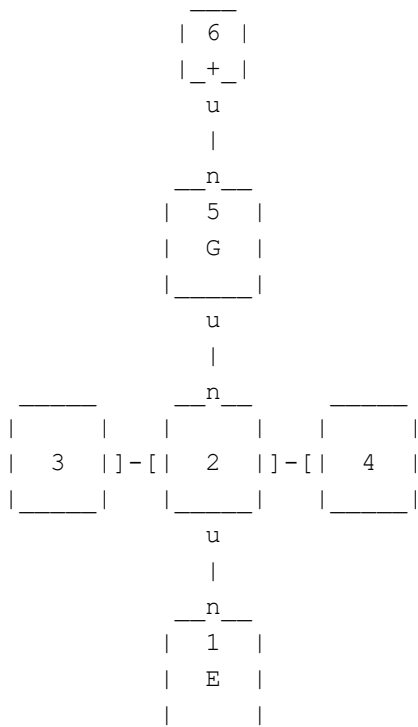

LAVA: GATE L-4 LEVEL 2

5.5.15 Lava Gate 4

Room 1 - Enemies: 5 Evil Vincents (2.0)

A typical room. Exit north to Room 2.

Room 2 - Enemies: 4 Bats, 4 Lava Imps

A lava filled room with catwalks. Cross and exit east to Room 3.

Room 3 - Enemies: 3 Spider Drone Generators (2.0)

This is a dangerous corridor. Mover through quickly unless you want a drag down fight. Exit south to Room 4.

Room 4 - Enemies: None

- Gun Upgrade

The east and west sides of this room are separated by a pit of lava. If you fall to the west you will not be able to get back up. Ignore the gun and exit south to Room 5.

Room 5 - Enemies: None

- Console

Destroy the Console in this room to deactivate the barrier (green) blocking the north exit of Room 7. Exit north to Room 4.

Room 4 - Now you may get the gun upgrade if you need it. Exit west to Room 1.

Room 1 - Exit west to Room 6.

Room 6 - Enemies: None (officially) - 2 rail-mounted multi-directional laser turrets (do not appear on radar, but a definite threat.)

This long storeroom should provide adequate cover from the laser fire if you cut right through the center of the boxes. The moving turrets can be destroyed by jumping and firing, or going hypersonic in air. Exit west to Room 7.

Room 7 - Enemies: 8 Evil Vincents (3.0)

The north end of this corridor will be blocked by a green barrier if you failed to destroy the console in Room 5. Exit east (north end) to Room 8.

Room 8 - Enemies: None.

A large pump sits in the middle of a pool of lava. The pool is surrounded, mostly, by a ledge. The east exit is separated from the north and west exits, and only the east edge can be accessed (via a floating platform) should you fall into the pool. Exit north to Room 9.

Room 9 - Enemies: None.

- Console

Destroying the console in this room will deactivate the barrier (red) blocking access to the elevator in Room 10. Exit south to Room 8.

Room 8 - Jump down from the ledge to the floating platform over the pool and access the east ledge. Exit east to Room 2.

Room 2 - Exit north to Room 10.

Room 10 - Enemies: None

- Elevator

The entrance will be blocked by a red barrier if you failed to destroy the console in Room 9. Ride the elevator to Level 2.

Level 2

Room 2-1 - Enemies: None

- Elevator

Exit north to Room 2-2.

Room 2-2 - Enemies: None

The floor of this room is covered with lava (shocking!) and has four-way catwalks to provide access to the exits. Exit west to Room 2-3.

Room 2-3 - Enemies: None

- Gun Upgrade

Stock up in this storeroom if you are in need. Exit east to Room 2-2.

Room 2-2 - Exit east to Room 2-4.

Room 2-4 - Enemies: None

- Gun Upgrade

All's quiet before the storm... A storeroom. Exit west to Room 2-2.

Room 2-2 - Exit north to Room 2-5.

Room 2-5 - Enemies: None

- Mini-garage

Prepare now for the next challenge... Exit north to Room 2-6.

Room 2-6 - WARNING!

You will find yourself on a checkered floor over lava. The checkered

pattern consists of solid-looking squares and transparent squares. All squares are equally solid, which is just to say that you need not fear falling into the lava. You do need to fear running into the lava plumes that will erupt around you, and the Bug-Eyed Fry Chicken boss. (Okay, so my nickname is a bit indignant, but what would you call him?) Refer to the Boss section below for a more in-depth strategy for fighting this poultry menace. Your opponent will go supernova if you win. Hop in the warp that opens to return, Sophia and all, to Ground.

5.6 Mission 5 - Water part 2

5.6.1 Rewards

Finally, some payoff on the hard work you've invested. Park in the nearby garage and your sister will hook you up with the submarine optional parts. Whenever you enter a body of water, Sophia will now transform into sub-mode allowing you free movement...with a few restrictions. First, Sophia maneuvers the same in water as on land except you cannot jump, including the side jump, unless a solid surface is beneath you. This means you can only exit water from shallow areas. Sophia will automatically sink when submerged, the sub-mode providing only providing horizontal movement automatically. Use the triangle button to control your depth - pressing it will move Sophia towards the surface. Pressing triangle when entering the water will keep Sophia on the surface. Jumping into the water will drop Sophia to the bottom like a rock.

5.6.2 Ground

Room 8 - Your next destination, though not stated explicitly in the game, should be obvious. Head back to Water to try out your new hardware. Head to Room 4, either taking the shortcut through Room 9, or going the long way around, 8-7-6-5-4.

Room 4 - Warp to Water

5.6.3 Water

Room 1 - Before continuing with the plot, it is possible to pick up a couple of multis that were previously inaccessible. To collect them, head to Room 11. (1-2-3-4-8-10-11)

Room 11 - Jump in the hole to exit to Room 12.

Room 12 - This room is the downhill tunnel with strong current. The first time through here you were swept through without any say in the matter. Now you can easily swim up stream. Head up the fork along the south wall and collect the multi in front of the exit. Technically (according to the way the story develops,) you shouldn't be able to pass through the sealed exit yet, but the game will let you (at least mine lets me.) Exit south to Room 16.

Room 16 - Enemies: None

- Multi

This small glyph lined room is typical of the bonus rooms in the game. A multi floats in the center. Collect and exit north to Room 12 and then return to Room 2 (16-12-13-7-1-2.)

Room 2 - Using sub-mode, the north exit is now accessible. Swim to the underwater ledge below the exit and hop out to dry land. Exit north to Water Part 2 and watch a cool movie.

5.6.4 Water part 2 Map

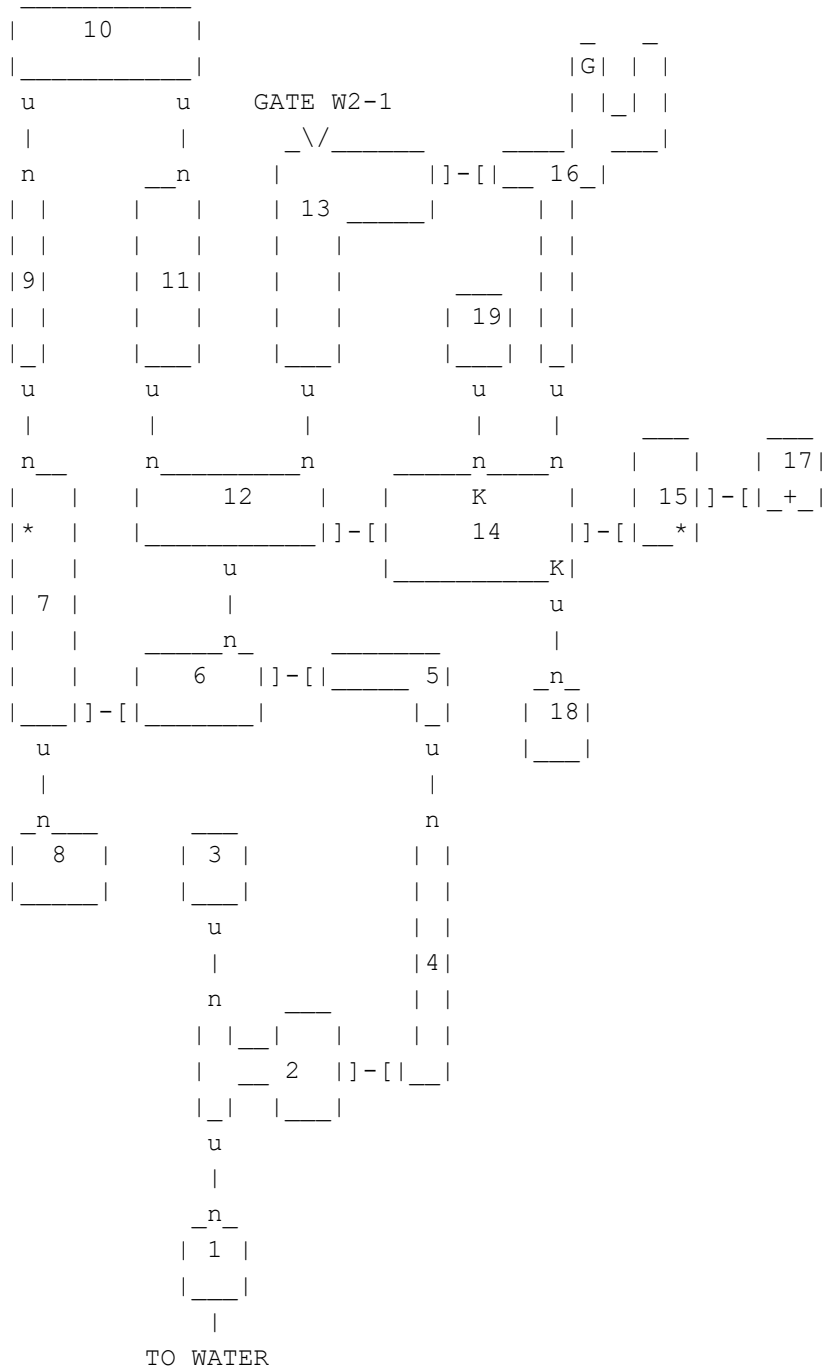

5.6.5 Water 2

There are two parts to each of the 'worlds' in the game (excepting Ground which is the hub between the other areas. The first four missions introduce you to each of the four realms, and then the last

four missions take you to the heart of each area. Water 2 is the first area you get to "re-explore."

Room 1 - Enemies: 3 Fireplants, 4 Mines

This room tests your fine maneuvering skills. Small ledges lace across a pool of water. Falling into the water may drop you on a mine, but most likely you will simply be stuck in a simple maze of channels too deep to jump out of. Exit north to Room 2.

Room 2 - Enemies: 4 Crabs (2.0)

This room consists of a tunnel that branches off to a small well. The east exit is at the bottom of the well. Exit north to Room 3.

Room 3 - Enemies: 2 Hover Tanks, 1 Large Hover Tank

This is an arena room. Destroy your opposition to unlock the doors. Exit south to Room 2.

Room 2 - Exit east to Room 4.

Room 4 - Enemies: 6+/- Narwhales

Navigate through these flooded catacombs. Exit north to Room 5.

Room 5 - Enemies: None

Another flooded tunnel. Exit west to Room 6.

Room 6 - Enemies: 3 Mantas

This is an open underwater cavern. Exit west to Room 7.

Room 7 - Enemies: 3 Narwhales, 3 Mines

- Beacon

With the third dimension now accessible (as long as it's underwater) some items and exits will be located in tricky locations at varying depths. Swim to the surface and climb onto the south ledge. Exit south to Room 8.

Room 8 - Enemies: 4 Flashlight Tanks

- Multi

This is a small room with a multi hidden in one of the rocks. Exit north to Room 7.

Room 7 - Swim across the surface of the water to the north ledge and shoot the Beacon. The Beacon will deactivate one of the barriers blocking the Gate in Room 13. Dive into the water and exit north to Room 9.

Room 9 - Enemies: None

This room is a submerged tunnel. Exit north to Room 10.

Room 10 - Enemies: 6+/- Narwhales (2.0)

Another submerged tunnel. Exit south (east side) to Room 11.

Room 11 - Enemies: 2 Hover Tanks, 2 Flashlight Tanks

You will need to destroy your adversaries in this room to move on. Do so, then exit south to Room 12.

Room 12 - Enemies: 3 Narwhales, 3 Mantas

This is a long, deep room. The exits are split with half being above the water and half at the bottom. Only the shore in the NE corner is accessible from the water, so the exit to Room 11 is essentially one-way. The center platform on the surface has a few nice items, but you

WATER 2: GATE W2-1 LEVEL 1

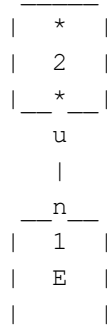

WATER 2: GATE W2-1 LEVEL 2

5.6.7 Water 2 Gate 1

Room 1 - Enemies: 3 Evil Vincent Generators (2.0)
 Typical first room. Exit west to Room 2.

Room 2 - Enemies: 6 Evil Vincents (3.0)
 The room is terraced with lots of pipes and some water. The west exit is inaccessible. Exit north to Room 3.

Room 3 - Enemies: 6 Evil Vincents (3.0 x3) (4.0 x3)
 A series of corridors. The east branches are dead ends. Exit west (north side) to Room 4.

Room 4 - Enemies: 3 Super Draconians
 - Gun Upgrade x2
 This is a storeroom. Loot it now, because it will soon be inaccessible. Exit east to Room 3.

Room 3 - Exit west (south side) to Room 5.

Room 5 - Enemies: 5 Bats, 2 Draconians
 - Gun Upgrade x2
 Another storeroom. Exit west to Room 6.

Room 6 - Enemies: 4 Bats, 1 Evil Vincent
 This is a large storeroom. The boxes are situated on dikes, to keep them from getting wet from the water, I suppose. The south exit is too high to reach. Exit north to Room 7.

Room 7 - Enemies: None
 - Installation
 The equipment at the back of this room is inactive. Elfie suggests you "activate the installation." How does one do such an activity with no

button with which to perform actions? With one's gun, of course! Jump up and shoot the round panel on the front of the machine until the equipment activates completely. (One can only assume that this unique piece of equipment is capable of absorbing the energy discharged from your gun, since all the rest go up in flames.) Once operational, the equipment will freeze the water in the Gate. The ice will allow access to some doors that were too high to reach standing in the water, but doors that are in the water will be sealed, permanently locking away anything behind them. Exit south to Room 6.

Room 6 - Hop across to the south exit now that you can leap off the ice instead of sinking into the water. Exit south to Room 8.

Room 8 - Enemies: 7 Evil Vincents (3.0 x3) (4.0 x4)

This is a large open room covered with ice. exit east to Room 9.

Room 9 - Enemies: 6+/- Evil Vincents (3.0)

- Gun Upgrade (x4)

Loot this storeroom and exit east to Room 2.

Room 2 - Dropping off the ledge you start on effectively makes the exit from room 8 one-way. The loop of rooms 3-9 is now inaccessible since the north exit from room 2 is blocked in the ice. Exit east to Room 1.

Room 1 - Exit west to Room 10.

Room 10 - Enemies: 5 Spider Drones

- Gun Upgrade (x4)

This storeroom has some pools in it. Guess that's a little different. Exit east to Room 11.

Room 11 - Enemies: 3 Dustpan and Firepod Generators

This is a dangerous corridor. The difficulty in hitting the Firepods, combined with the wide range of fire of the Dustpans, makes this room a good candidate to just run through. Exit north to Room 12.

Room 12 - Enemies: None

- Console

Destroy the console in this room to deactivate the barrier at the entrance of Room 15. Exit south to Room 11.

Room 11 - Exit west to Room 10.

Room 10 - Exit west to Room 1.

Room 1 - Exit north to Room 13.

Room 13 - Enemies: 5 Evil Vincents

This is a large skating rink, though impassable prior to being frozen. Exit east to Room 14.

Room 14 - Enemies: None

- Multi

A gift to you. Exit west to Room 13.

Room 13 - Exit north to Room 15.

Room 15 - Enemies: None

- Elevator

The elevator will be blocked by a white barrier if you failed to destroy

the console in Room 12. Ride the elevator to Level 2.

Level 2

Room 2-1 - Enemies: None
- Elevator

Exit north to Room 2-2.

Room 2-2 - Enemies: None
- 2 Pumps

Take out the pumps in this equipment room. Doing so stops the flow of the water barrier in Water 2 Room 15. Exit south to Room 2-1

Room 2-1 - Take the elevator to Level 1.

Level 1

Room 15 - Exit south to Room 13.

Room 13 - Exit south to Room 1.

Room 1 - Exit south to Water 2 Room 13.

5.6.8 Boss

Water 2

Room 13 - Exit east to Room 16.

Room 16 - Save if you wish, then exit south to Room 14.

Room 14 - Exit east to Room 15.

Room 15 - Gird up your loins and exit to Room 17.

Room 17 - WARNING!

The boss is a beefed-up version of the boss encountered in Mission 1. This time, however, it hits harder, faster, and covers more area with its attacks. Note that there is a depression around the perimeter of the room that can be used for cover. See the boss section for in-depth strategy on how to tackle this adversary, though Thunder will go a long way... Once victory has been secured, Sophia and Roddy will be warped back to Ground.

5.7 Mission 6 - Cave part 2

5.7.1 Rewards

Stop in the nearby garage to pick up the spoils from your last mission. Elfie will send you parts for Boost. With Boost Sophia will be able to literally streak along the ground at roughly twice normal speed. The extra momentum will allow you to make longer jumps, and add a little altitude. Press the triangle button while moving to activate Boost. While it may seem that you have unlimited boosting capabilities, Boost actually drains energy from an auxiliary energy cell, the capacity of which is displayed as the amount of color of the orb in the center of the life gauge. (The orb changes color based on which secondary weapon

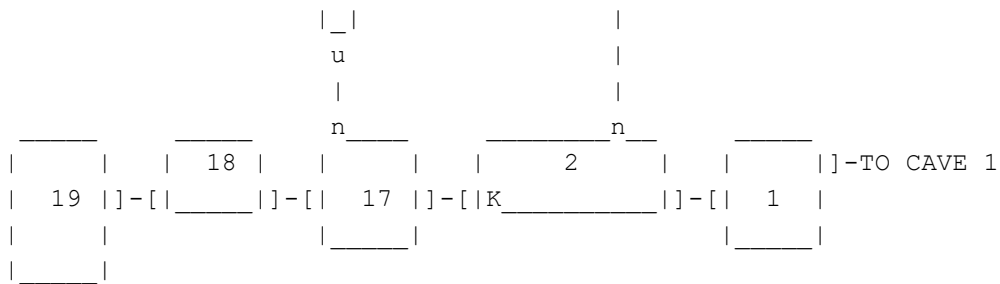

CAVE 2

5.7.4 Cave 2

Room 1 - Enemies: None

The door will shut behind you, locking you in the level. You won't be able to return to Ground to repair damage at a garage until you find one on this level, so take care of Sophia. The room is a large open cavern with ledges and blind jumps that hide pits of radioactive goo. Use Boost jump to get to places that normally would be unobtainable. Exit west to Room 2.

Room 2 - Enemies: 6 Crabs (2.0 x3)

- Key required for west exit.

After leaving Room 1, you get to watch a movie with mediocre voice acting (don't worry, it gets worse.) This tunnel appears empty, but there is a ledge along the south wall that is packed with container concealing a vast multitude of items. Exit north to Room 3.

Room 3 - Enemies: 1 Trooper with Rocket Launcher

This room is not an arena, so if you aren't interested in challenging the Trooper, you are free to leave. Exit east to Room 4.

Room 4 - Enemies: 6 Crabs (2.0 x3)

A small set of catacombs. An Omega Item can be found at the end of the tunnel. Exit west to Room 3.

Room 3 - Exit north to Room 5.

Room 5 - Enemies: 3 Dual Missile Launchers, 4 Face Cannons

- Key required for west exit.

This cavern has many tricky jumps. The missile launchers complicate navigation, so be wary, and Field Guard can be useful if you've upgraded it. Exit east to Room 6.

Room 6 - Enemies: None

Just a tunnel. Exit north to Room 7.

Room 7 - Enemies: 2 Whirligigs, 6 Dual Cannons

- Key required for East exit

Another movie will be played when entering the room. This is a large cavern with plenty to shoot at. Use Boost jump to reach the various ledges, or ride the antiquated floating platforms. If you look carefully, you can find a fossil of the level one boss from the first game. Exit north to Room 8.

Room 8 - Enemies: None

Another tunnel. Exit west to Room 9.

Room 9 - Enemies: 1 Bomber, 3 Hover Tanks.

The Bomber will make this long room tedious if you don't take it out first. Energy pistons decorate the room and still can't be destroyed. To reach the west exit, ride up on a platform nestled in a niche on the north face of the west cliff. Exit west to Room 10.

Room 10 - Enemies: None

- Key required for SW exit

Yet another empty tunnel, though this one is not quite as boring as the last two. Exit west (north) to Room 11.

Room 11 - Enemies: None

- Key required for west exit

- Gate C2-1

Exit Sophia and enter Gate C2-1.

Gate C2-1

Room 1 - There is only one room here, and it hosts a cut scene. Enjoy the conversation then exit south back to Cave 2 Room 11.

Room 11 - Exit east to Room 10.

Room 10 - Exit east (south) to Room 12.

Room 12 - Enemies: None

- Garage

Save if you so desire, then exit west back to Room 10.

Room 10 - Exit east (north) to Room 9

Room 9 - Exit east to Room 8

Room 8 - Exit south to Room 7

Room 7 - Exit south to Room 6

Room 6 - Exit west to Room 5

Room 5 - Entering this room will initiate a movie. Roddy is frustrated with the current situation, damn it, and he wants to share his feelings. Once he's been calmed down and the sequence ends, you will have been awarded the 'Key.' It isn't explicitly referred to as a key, nor does it have a corporeal representation, but you now can pass through the exits sealed with the glyph inscribed walls that look like gate entrances without doors, and keeping with the spirit of the first game, in which you were awarded a key, I've dubbed this new ability as the Key. (Faulkner eat your heart out.) 'Nuff said, exit east to Room 6.

Room 6 - Exit north to Room 7

Room 7 - Exit east, to try out this new Key thing, to Room 13.

Room 13 - Enemies: None

- Multi

This room is another glyph room. Collect your multi and exit west to Room 7.

Room 7 - Exit south to Room 6

Room 6 - Exit west to Room 5

Room 5 - Continuing where we left off earlier, exit west to Room 14.

Room 14 - Enemies: 6 Crabs (2.0)

- Multi

Clean the Crabs out of these catacombs and collect another upgrade.

Exit west to Room 15.

Room 15 - Enemies: 3 Whirligigs, 2 Hover Tanks

A cavern with radioactive goo between ledges. Use Boost jump to navigate this chamber. Exit south to Room 16.

Room 16 - Enemies: None

This is a stepped tunnel, but note that there are two west exits; one high, the other low. Exit south, for now, to Room 17.

Room 17 - Enemies: 4 Tarantulas

This room is filled with trenches and shallow water. It requires careful jumping to cross. Exit west to Room 18.

Room 18 - Enemies: None

This room is long, cut transversely by goo filled trenches. Exit west to Room 19.

Room 19 - Enemies: 3 Mantas, 5 Fireplants

- Multi

The NW corner of the rock face opposite the lake in front of where you start is your destination. You will have to use your much neglected Climb function to reach the summit. Collect your spoils and exit east to Room 18.

Room 18 - Exit east to Room 17

Room 17 - Exit north to Room 16

Room 16 - Exit west to Room 20 via the top exit. There isn't much room to set up on the steps, so timing is crucial. Start on the step face about level with the upper tunnel (otherwise you'll jump into the wall) and then press forward, immediately activate Boost, and then jump.

Room 20 - Enemies: 6 Flashlight Tanks (2.0)

This is a split-level room, the top of the towers creating the upper floor which can only be accessed by the upper exit from Room 16.

Practice breaking when landing from Boost jumps, as such control will be crucial for navigating parts of this level. The NW exit is on the upper level. Exit north (west) to Room 21.

Room 21 - Enemies: 1 Trooper with Rocket Launcher.

- Multi

This long narrow room is decorated with more energy pistons. The center of the room is depressed, forcing you to use the floating platforms should you wish to travel north-south. Only the east exit is accessible if you fall into the center section. Drop into the center area and destroy the Trooper. Collect the multi hidden in the small alcove under the south ledge. Exit east to Room 22.

Room 22 - Enemies: 6 Flashlight Tanks

These catacombs have a few goo pits to liven them up. Exit north to Room 25.

Room 25 - Enemies: 3 Tarantulas, 4 Flashlight Tanks

The tanks occupy the trench that runs north-south through this room, while the Tarantulas lurk on the main floor above. The trench limits movement to north and south. Being in the trench, exit north to Room 26.

Room 26 - Enemies: 8 Flashlight Tanks

From your current perspective, this room appears to be a dead-end. However, above is a tunnel that crosses east-west with a hole in the floor that deposits the unwary in the pit below - where you are now. Having seen this room, exit south back to Room 25.

Room 25 - Exit south (unless you want to go back and hang out with the Flashlight Tanks again) to Room 22.

Room 22 - Exit east to Room 23.

Room 23 - Enemies: None

This room is a stepped tunnel. Exit north to Room 24.

Room 24 - Enemies: 3 Troopers

- Multi

This room is an arena. Destroy the three troopers to proceed. Keep in mind the Troopers are relatively land bound. The center platform can be used as a safe-zone. Collect the multi awarded for victory. Exit west to Room 25.

Room 25 - Cross the room without falling in the trench, knowing where it leads, and exit west to Room 27.

Room 27 - Enemies: 7+/- Crabs (2.0)

A branched tunnel. Exit north to Room 28.

Room 28 - Enemies: 3 Bombers

- Gate C2-2

This is a large room with radioactive goo covering the floor. A small road leads down from the south cliff, but it is intended more for Roddy than Sophia. Dispatch the Bombers and exit Sophia. A floating platform circles quickly through the room and will skim the ground in the SW corner, allowing Roddy a safe opportunity to hop on. Fly to the ledge on the north wall and enter Gate C2-2.

5.7.5 Cave 2 Gate 2 Map

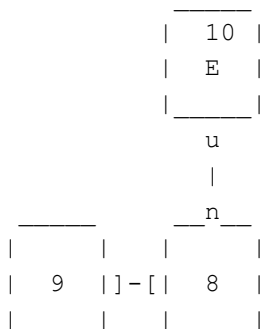

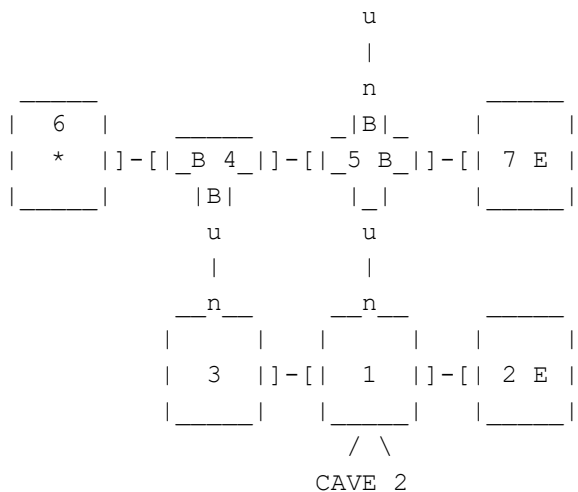

CAVE 2: GATE C2-2 LEVEL 1

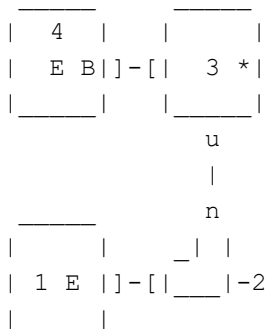

CAVE 2: GATE C2-2 LEVEL 2

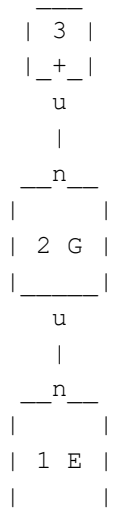

5.7.6 Cave 2 Gate 2

Room 1 - Enemies: 2 Evil Vincent Generators (2.0)
Typical room. Exit east to Room 2.

Room 2 - Enemies: None
- Elevator (to 2-1)
Take the elevator up to Level 2.

Level 2

Room 2-1 - Enemies: None
- Elevator (to 1-2)
Exit east to Room 2-2

Room 2-2 - Enemies: None
A corridor with floor spikes. In areas where the spikes are close together, hurdling them by jumping diagonally will keep Roddy from landing on the next set. Exit north to Room 2-3.

Room 2-3 - Enemies: None
- Console
Destroy the console to deactivate the barrier (orange) blocking the west exit of Room 1-4. Exit south to Room 2-2.

Room 2-2 - Exit west to Room 2-1

Room 2-1 - Ride elevator to Level 1.

Level 1

Room 2 - Exit west to Room 1.

Room 1 - Exit north to Room 5

Room 5 - Enemies: 6+/- Evil Vincents (3.0 and 4.0)
This is a donut shaped corridor with a purple barrier blocking access to the east and north exits. Exit west to Room 4.

Room 4 - Enemies: 3 Spider Drone Generators
Laser fences in this corridor will slow your progress and force confrontation with the Drones. The south branch is blocked by a green barrier, and the west branch will be blocked by an orange barrier if you failed to destroy the console in Room 2-3. Exit west to Room 6.

Room 6 - Enemies: None
- Console
- Gun Upgrade
Destroy the console in this storeroom to deactivate the green barrier in Rooms 4 and 2-4. Exit east to Room 4.

Room 4 - Exit south to Room 3.

Room 3 - Enemies: 2 Rail Lasers, 3 Super Draconians
- Gun Upgrade (x4)
Clean out this storeroom to power up your gun. Exit east to Room 1.

Room 1 - Exit east to Room 2

Room 2 - Ride elevator to Level 2

Level 2

Room 2-1 - Exit east to Room 2-2

Room 2-2 - Exit north to Room 2-3

Room 2-3 - Exit west to Room 2-4

Room 2-4 - Enemies: None

- Elevator (to 1-7)

Ride the elevator to Level 1.

Level 1

Room 7 - Enemies: None

- Elevator (to 2-4)

Exit west to Room 5.

Room 5 - The west and south exits are now blocked by the relative positions of the purple barriers. Exit north to Room 8.

Room 8 - Enemies: 2 Spider Drones

The center column in this room rotates emitting three laser beams.

While the beams themselves are not dangerous, crossing them as they sweep the room will set off an alarm. Each time the alarm sounds two Evil Vincent Generators will activate, each sending forth two drones. Exit west to Room 9.

Room 9 - Enemies: 4 Bats, 2 Draconians

- Gun Upgrade (x3)

A storeroom. Exit east to Room 8.

Room 8 - Exit north to Room 10.

Room 10 - Enemies: None

- Elevator (to 3-1)

Ride the elevator down to Level 3.

Level 3

Room 3-1 - Enemies: None

- Elevator (to 1-10)

Exit north to Room 3-2.

Room 3-2 - Enemies: None

- Mini-garage

Take a breather and save. Once you're ready, exit north to Room 3-3.

Room 3-3 - WARNING!

You've seen this guy before. You don't like him. He won't be running away this time. You'll find yourself on an octagonal shaped platform. You can't fall off, so no worries. The Emissary will move around slowly and discharge large orbs to each corner. You can destroy the orbs, but for at the beginning, it may be better to concentrate fire on the enemy.

A path will appear briefly between the orbs indicating where the Emissary will fire. Place yourself in a safe area and counter attack. Be wary destroying orbs while the Emissary is attacking as the shot pattern may change adversely. For more in-depth strategy see the Boss section below. Note that pressing the L/R2 buttons will zoom in and out during this stage. Once you've eliminated the Emissary, take the warp back to Ground 2.

5.8 Mission 7 - Lava part 2

5.8.1 Rewards

Elfie had the hover parts ready and waiting shortly after you entered Cave 2. Now you can finally claim them. Hover is activated by pressing the triangle button while either stationary or in the air. If you are moving when you try to Hover you will activate Boost instead. You can Hover to get out of water, but only if you are in a shallow area where you would be able to jump. Hover drains the same energy reserve that Boost uses, though the rate of consumption is much higher. Therefore, if you drain your reserves hovering, you will not be able to Boost but for short bursts after landing. With Hover, Sophia is now able to traverse all terrain. You may find it convenient to shuffle buttons around so you can utilize all of Sophia's abilities easily and still be able to side jump in both directions. Sophia is highly maneuverable once Hover has been attained, but only being able to strafe left may be limiting in certain situations.

5.8.2 Scavenge

Sophia now has all of the optional parts installed. The only things left to power up are the secondary weapons. Each can be upgraded to a maximum of eight levels. Now is a good time to go back and collect multis that were previously inaccessible. When is it not good to maximize one's firepower as soon as possible?

Cave

Room 3 - Use the 'Key' to exit west to Room 16
Room 16 - Glyph room
Room 5 - Multi on north ledge
Room 13 - Multi in the center of the room.

Water

Room 4 - Multi along north wall

Water 2

Room 14 - Use the 'Key' to access Room 18 and Room 19
Room 18 - Glyph room
Room 19 - Glyph room

Lava

Room 2 - Floating multi
Room 3 - Use the 'Key' to access Room 13
Room 13 - Glyph room

Lava 2

Room 1 - Enemies: 1 Bomber, 5 Face Cannons

This large room has a high rock ramp leading up to the north. The west exit is sealed. Exit east to Room 2.

Room 2 - Enemies: 3 Flashlight Tanks

This room is essentially a lava pit. Avoid the flares when crossing the room. Exit south to Room 3.

Room 3 - Enemies: None

- multi

A glyph room. Exit north to Room 2.

Room 2 - Exit north to Room 4.

Room 4 - Enemies: None

This is a long lava flow. A platform on the north face of the lava flow will allow passage up from the bottom. Exit east to Room 5.

Room 5 - Enemies: None

- Beacon

Shoot the beacon to deactivate a barrier blocking the Gate in Room 14.

Exit west to Room 4.

Room 4 - Exit north to Room 6.

Room 6 - Enemies: None

This room is a huge lava cave. The fiery walls create a zigzag passage that you must Hover through. While there are floating platform to assist, there are also stone ledges that can be reached through judicious use of your hover jets by igniting them in short, controlled bursts. Exit north to Room 7.

Room 7 - Enemies: 3+/- Fireplants

Islands break up this lava river. Exit east to Room 8.

Room 8 - Enemies: None

- Beacon

The lava river continues into this room, along with many islands. A barrier sweeps back and forth above the center islands, so you will need to time your jump/hover over it. Also watch for lava flares. Shoot the beacon at the end of the room to deactivate another barrier blocking the gate in Room 14. Exit west to Room 7.

Room 7 - Exit west to Room 9.

Room 9 - Enemies: 5 Face Cannons

This large, lava floored cavern has a lattice of bridges. The room is tall and the exits are at different elevations along the walls. Exit west to Room 10.

Room 10 - Enemies: 3 Bombers

- Beacon

Another open river of lava with large flares. Large floating platforms will need to be navigated to reach the end of the room. Shoot the Beacon to deactivate another layer of barriers covering the gate in Room 14. Exit east to Room 9.

Room 9 - Exit south to Room 11.

Room 11 - Enemies: 1 Whirligig, 2 Missile Launchers
- Beacon

Another, though longer, zigzag lava cavern with floating platforms.
Pause halfway through the room long enough to shoot the beacon and deactivate the final barrier guarding the gate in Room 14. Exit south to Room 12.

Room 12 - Enemies: 6 Fireplants

A series of stepped ledges create a path through the lava river in this room. Avoid the flares, and exit west to Room 13.

Room 13 - Enemies: 3 Dual Missile Launchers

This is an arena with similar topography to the previous room. Field Guard will help protect you against the onslaught of missiles you will face here. Launcher that can be eliminated at long range are not threats, however. Destroy the enemies to proceed. Exit west to Room 14.

Room 14 - Enemies: None

- Gate L2-1

This room is a deep, lava filled canyon. The south exit is sealed. Exit north to Gate L2-1.

5.8.5 Lava 2 Gate 1 Map

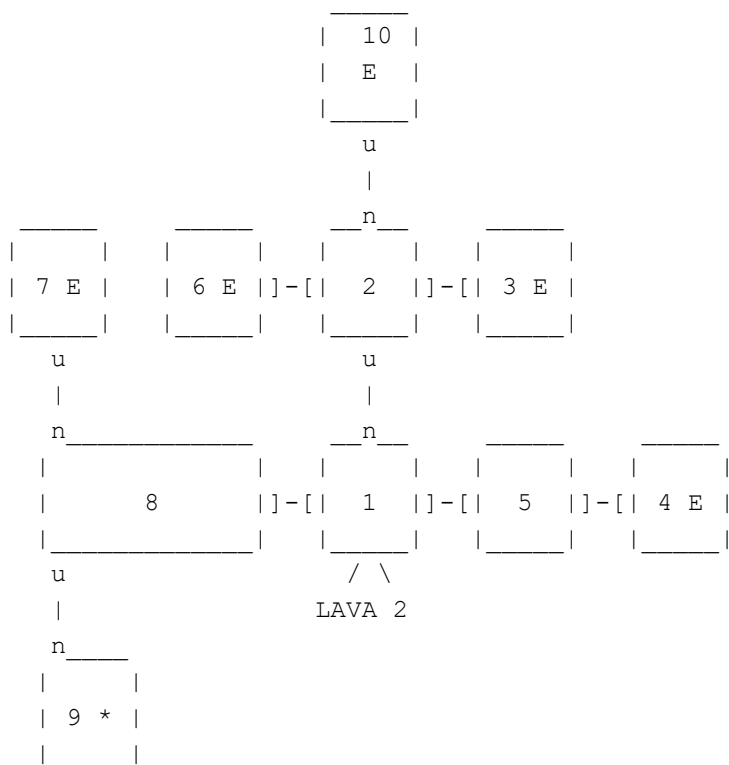

LAVA 2: GATE L2-1 LEVEL 1

```

|_____|
|  3  |

```

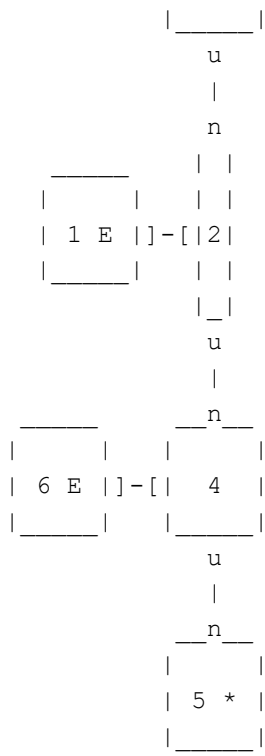

LAVA 2: GATE L2-1 LEVEL 2

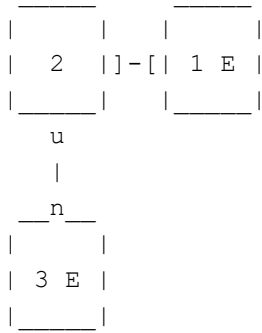

LAVA 2: GATE L2-1 LEVEL 3

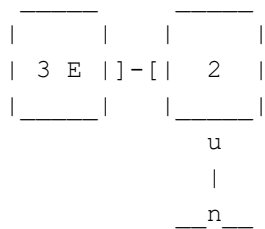

```
|   |  
| 1 E |  
|_____|
```

LAVA 2: GATE L2-1 LEVEL 4

```
|_____| |_____| |_____|  
| 3 + | ]-[|B G B|]-[| 1 E |  
|_____| |_____| |_____|
```

LAVA 2: GATE L2-1 LEVEL 5

5.8.6 Lava 2 Gate 1

Room 1 - Enemies: 3 Evil Vincent Generators (2.0)
Typical room. Exit north to Room 2.

Room 2 - Enemies: None

- Gun Upgrade (x4)

A lava pit in the center of this room surrounds an island with lots of goodies on it. A fast moving floating platform is there to assist you in accessing them if you so choose. Exit east to Room 3.

Room 3 - Enemies: None

- Elevator (to 2-1)

Ride the elevator up to Level 2.

Level 2

Room 2-1 - Enemies: None

- Elevator (to 1-3)

Exit east to Room 2-2.

Room 2-2 - Enemies: 8 Evil Vincents (4.0)

The corridor is broken up by a laser fence. Exit north to Room 2-3.

Room 2-3 - Enemies: 3 Super Draconians, 6+/- Bats

- Gun Upgrade (x4)

You will need to eliminate all of the enemies in this storeroom to proceed. Exit south to Room 2-2.

Room 2-2 - Exit south to Room 2-4.

Room 2-4 - Enemies: 2 Super Draconians, 1 Draconian

This is a large, open room with four pieces of equipment that can be destroyed. Exit south to Room 2-5.

Room 2-5 - Enemies: None
- Console

Destroy the console to deactivate the blue barrier blocking the west exit of Room 5-2. Exit north to Room 2-4.

Room 2-4 - Exit west to Room 2-6.

Room 2-6 - Enemies: None
- Elevator (to 1-4)

Ride the elevator to Level 1.

Level 1

Room 4 - Enemies: None
- Elevator (to 2-6)

Exit west to Room 5.

Room 5 - Enemies: 8+/- Bats
- Gun Upgrades (x2)

Clean out this storeroom and exit west to Room 1.

Room 1 - Exit north to Room 2.

Room 2 - Exit west to Room 6.

Room 6 - Enemies: None
- Elevator (to 3-1)

Ride the elevator up to Level 3.

Level 3

Room 3-1 - Enemies: None
- Elevator (to 1-6)

Exit west to Room 3-2.

Room 3-2 - Enemies: 6 Bats, 3 Lava Imps

The floor of this room is covered with lava. Catwalks provide access to the other exit. Exit south to Room 3-3.

Room 3-3 - Enemies: None
- Elevator (to Room 1-7)

Ride the elevator down to Level 1.

Level 1

Room 7 - Enemies: None
- Elevator (to Room 3-3)

Exit south to Room 8.

Room 8 - Enemies: None

The main floor of this room is covered with lava. A high ledge connects the north and south exits along the west wall. Access to this ledge is unobtainable from the east. Exit south to Room 9.

Room 9 - Enemies: None
- Console

Destroy the console to deactivate the orange barrier blocking the east exit of Room 5-2. Exit north to Room 8.

Room 8 - Jump down from the ledge and exit east to Room 1.

Room 1 - Exit north to Room 2 (getting tired of this yet?)

Room 2 - Exit north to Room 10 (whoa, bet you weren't expecting that...)

Room 10 - Enemies: None
- Elevator (to 4-1)

Ride the elevator up to Level 4.

Level 4

Room 4-1 - Enemies: None
- Elevator (to 1-10)

Exit north to Room 4-2.

Room 4-2 - Enemies: 3 Spider Drone Generators (2.0)
If you're up for a good fight, take on these guys. If you'd rather finish this level, run through this corridor. Exit west to Room 4-3.

Room 4-3 - Enemies: None
- Elevator (to 5-1)

Ride the elevator to Level 5.

Level 5

Room 5-1 - Enemies: None
- Elevator (to 4-3)

Exit west to Room 5-2.

Room 5-2 - Enemies: None
- Mini-garage

If you failed to destroy the consoles before coming here, the east exit will be blocked by an orange barrier, and the west exit will be block by blue one. Save, then exit west to Room 5-3.

Room 5-3 - Enemies: None
- Gun Upgrade
- Equipment

Clear out the boxes in this room, then destroy the equipment along the west wall to open the south exit in Room 14 of Lava 2. Oh, and to start a self-destruct sequence. You will now have 5 minutes to exit the Gate or be incinerated in its fiery demise. Time will not elapse when viewing the map screen, so pause it as frequently as necessary to maintain your bearings. Try not to engage in fights unless necessary, as doing so could waste precious time and health, as random explosions could injure you as you try to escape. Exit east to Room 5-2.

Room 5-2 - The garage will be in smoldering shambles and therefore unusable. Glad you saved earlier, aren't you. Exit east to Room 5-1.

Room 5-1 - Take the elevator to Level 4.

Level 4

Room 4-3 - The elevator will collapse once you get off it. All elevators will behave in the same fashion. You get to ride it once, that's all. Exit east to Room 4-2.

Room 4-2 - Exit south to Room 4-1

Room 4-1 - Take the elevator to Level 1.

Level 1

Room 10 - Exit south to Room 2.

Room 2 - Oh, this is going to be easier than you thought, four minutes to go and one room away from escape. Oh, but what is that large pile of flaming debris blocking the south exit? Crap. Guess poor Roddy will be taking the scenic tour. Exit west to Room 6.

Room 6 - Ride the elevator to Level 3.

Level 3

Room 3-1 - Exit west to Room 3-2

Room 3-2 - Exit south to Room 3-3

Room 3-3 - Ride the elevator back to Level 1

Level 1

Room 7 - Exit south to Room 8.

Room 8 - You're almost out, but the building is already falling down around your ears. Watch out for falling debris that will damage you as you try to get back to Sophia. Exit east to Room 1.

Room 1 - Quick, exit south to Lava 2!

5.8.7 Boss

Room 14 - The gate explodes and is no longer accessible. But, the south exit has been unlocked. Hop in Sophia and exit south to Room 15.

Room 15 - Enemies: 3 Bombers
- Garage

This is a large lava filled cavern. Watch out for the non-flashing platforms that will drop into the lava if you land on them. The power items will recharge your Hover if you are running low. Save and then exit east to Room 16.

Room 16 - WARNING!

You will find yourself flying over a seemingly endless river of lava. The boss will arrive and circle around in front of you. For this encounter you have unlimited automatic Hover and the directional controls move you around the screen (i.e. you don't need to use the triangle button.) Dodge the various attacks thrown at you as well as the boss itself, which will make passes at you and try to knock you out of the air. After it has sustained enough damage the river will flare up with lots of small eruptions reducing the amount of maneuvering room available. See the Boss section for a more detailed strategy. When you finally manage to dispatch the fiend you'll get to watch a cut-scene, and then be deposited in Room 1. You'll have to return to Ground on your own this time.

```

| | | | _G_ | | 23 | | _____ | | | |
_n | | | | | | | | | | 21- | | | |
| 16 | | | _____ | _____ | | _____ | | | | | | | |
|_*_| | | _____ | u u | | ]- [ | _____ | ]- [ | 28_ | ]- [ | 29 |
|_| |_| | | | | | 27 | | | | | _G_ |
u u n_ n_ | | | | | | | |
| | | | | 25 | | u | | u |
_n_ _n_ | | |_*_| | | | |
| 15 | | | 17 | | _____ n _____ _n_ _____
|_G_| | _____ | ]- [ | 26_ | | 20 | ]- [ | 18 | ]- [ | 19 |
|_*_| | _____ | | _G_ |

```

PLANT 2

5.9.3 Plant 2

This level is pretty extensive, and with good reason. Reincarnations of each of the previous seven bosses are scattered around the area waiting to lock horns with you for a chance to regain their dignity.

Room 1 - Enemies: None

Just a room with a large tree. You can hover to the top of most trees. Exit south to Room 2.

Room 2 - Enemies: 6 Flashlight Tanks, 2 Tarantulas (green)

This is a large cavern with lots of drop-offs. Nothing you can't navigate through, however. Exit south (center) to Room 3.

Room 3 - Enemies: None

- Garage

Save and exit south to Room 4.

Room 4 - Enemies: Mission 1 Boss

- Multi

Let the festivities begin! Drive Sophia into the warp in the center of this glyph room to be transported to your first boss fight of the level. When you finish the fight you will warp back to the glyph room and be rewarded with a multi. The first orb of the barrier in Ground Room 9 will shatter. Exit north to Room 3.

Room 3 - Save. Exit north to Room 2.

Room 2 - Exit south (east side) to Room 36.

Room 36 - Enemies: None

This room consists of two tunnels that cross each other but don't actually connect. Exit south to Room 35.

Room 35 - Enemies: None

A short tunnel. Exit west to Room 34.

Room 34 - Enemies: 2 Dual Missile Launchers

This room is a deep canyon with radioactive goo at the bottom. Exit north to Room 36.

Room 36 - You are in the other tunnel this time. Exit west to Room 2.

Room 2 - Okay, that seems to have been a pointless loop, but it actually served an important purpose. It allowed me to show you those rooms. Exit south (west side) to Room 5.

Room 5 - Enemies: None
A tunnel. Exit west to Room 6.

Room 6 - Enemies: 6+/- Crabs
The east-west tunnel is not connected to the rest of the catacombs inhabited by the crabs. Exit west to Room 7.

Room 7 - Enemies: None
Yet another tunnel. Exit north to Room 8.

Room 8 - Enemies: 6 Tarantulas.
A long room with ledges, goo, and floating platforms. Hey, it's got it all. The NW exit is concealed in the south face of a cliff. Be careful around it though, as it is a one-way trip down. Exit north (east side) to Room 9.

Room 9 - Enemies: None
- Garage
Save and exit south to Room 8.

Room 8 - Exit east to Room 37 (like I said, the NW exit is one-way, and it's a long way back.)

Room 37 - Enemies: Mission 7 Boss
- Multi
Enter the warp in this glyph room and take down your adversary. You should still be warmed up from your last encounter with him, so put him away quickly. The second orb in the waterfall barrier will shatter and you'll be awarded another multi (should you even need them at this point.) Exit west to Room 8.

Room 8 - Exit to 9 and save if you would like. When you are ready, hop down the hole and exit north (west side) to Room 10.

Room 10 - Enemies: None
This tunnel only goes east-west. Exit east to Room 11.

Room 11 - Enemies: None
More tunnels. Exit north to Room 12.

Room 12 - Enemies: Mission 2 Boss
- Gun Upgrade (x2)
- Multi
Roddy will have to take this one on his own. Collect the guns if you need them, then warp to the boss. The third orb in the waterfall barrier will be destroyed when you win and you'll be awarded a multi. Exit south to Room 11.

Room 11 - Exit south to Room 6.

Room 6 - Eliminate all enemies to proceed. Exit west (south end) to Room 13.

Room 13 - Enemies: 3 Jets, 2 Dual Missile Launchers
This is a large terraced room. Exit south to Room 14.

Room 14 - Enemies: None
A branching tunnel. Exit south (center) to room 15.

Room 15 - Enemies: None
- Garage
Save and exit north to Room 14.

Room 14 - Exit south (west side) to Room 16.

Room 16 - Mission 5 Boss
- Multi
Drive into the warp and take on the next boss. Winning shatters the fourth orb in the waterfall barrier and nets you a multi. Exit north to Room 14.

Room 14 - Exit to 15 and save if needed. Exit south (east side) to Room 17.

Room 17 - Enemies: 3 Fireplants
This is a pretty open room. It is dark with many small islands that act as stepping stones to the north exit. Fall into the depths and exit to Room 18.

Room 18 - Enemies: None
You will land in a small pond with terraced banks. The west exit is concealed behind the waterfall. Exit east to Room 19.

Room 19 - Enemies: None
- Garage
Save. Exit west to Room 18.

Room 18 - Exit west to Room 20.

Room 20 - Enemies: Mission 3 Boss
- Gun Upgrade (x2)
- Multi
Exit Sophia and warp Roddy to the boss fight. Upon his return he'll be awarded another multi, and the fifth orb will shatter in the waterfall barrier. Exit east to Room 18.

Room 18 - Exit north to Room 21.

Room 21 - Enemies: 3 Troopers with Rocket Launchers
- Multi
The east-west branch of this room is a tunnel across the ceiling of the north-south room. Destroy the Troopers to receive the multi. Exit west (north side) to Room 22.

Room 22 - Enemies: 3 Hover Tanks
A deep terraced room. Exit west to Room 23.

Room 23 - Enemies: 3 Troopers with Rocket Launchers
You will need to destroy the Troopers to continue. The base of the tree trunk is a relatively safe spot to snipe them with Homing Missiles. The multi will be waiting at the very top of this tall tree, though you may wish to save it for later if you need it, as getting up the tree is perhaps one of the more difficult parts of the level. Exit west to Room

24.

Room 24 - Enemies: None

- Garage

Save. Exit east to Room 23.

Room 23 - Exit south (east side) to Room 25.

Room 25 - Enemies: Mission 4 Boss

- Gun Upgrade (x2)

- Multi

This one is for Roddy. Return victorious and the sixth orb in the waterfall barrier will shatter and another multi will be awarded. Exit north to Room 23.

Room 23 - Exit to 24 if you wish to save. The SW exit is located high up on the wall. To get to it you will need to climb the tree. I recommend starting on the flared portion of the south side of the trunk. Position yourself just right of center. Jump and start hovering at the apex. Right before you r

This document is copyright PRadley and hosted by VGM with permission.