

# Digimon World 3 Circuit Board Guide

by Shalios

Updated on Jan 29, 2019

## DW3 Circuit Board Maps

### Brief introduction about the maps

These maps were made based on the Circuit Board pattern scenarios, which are 7 in total.

Each rectangle corresponds to a scenario. The squares with an arrow indicate an exit (hole) and near them is indicated the place where it is. The letters that appear in some rectangles are the initial letter of the digimon that is in that place (to help in the guidance): A (Agumon), V (Veemon), G (Guilmon), R (Renamon), M (Mommon) and B (Bearmon, aka Kumamon).

Places that have more than one hole come with a reference. This reference can be something close (such as a ladder, ramp or cliff) or a direction relative to the center of the place: north (N), south (S), east (E) or west (W).

There are also indications of items that can be found (chips and equipment) and legendary cards (BlackAgumons and Numemons), remembering that the latter will only be available after getting the Sun Trophy. They were written in rectangles and the items are in red, BlackAgumons in grey and Numemons in green.

The 7 pattern scenarios are (details in the next section):

1. One path to north and two paths to south;
2. Two paths to north and one path to south;
3. One path to north and south and two dead-ends;
4. A hole and a path to south;
5. A hole and a path to north;
6. A path from south to a dead-end north
7. A path from north to a dead-end south

### The 7 pattern scenarios

Pattern scenario 1: one path to north and two paths to south

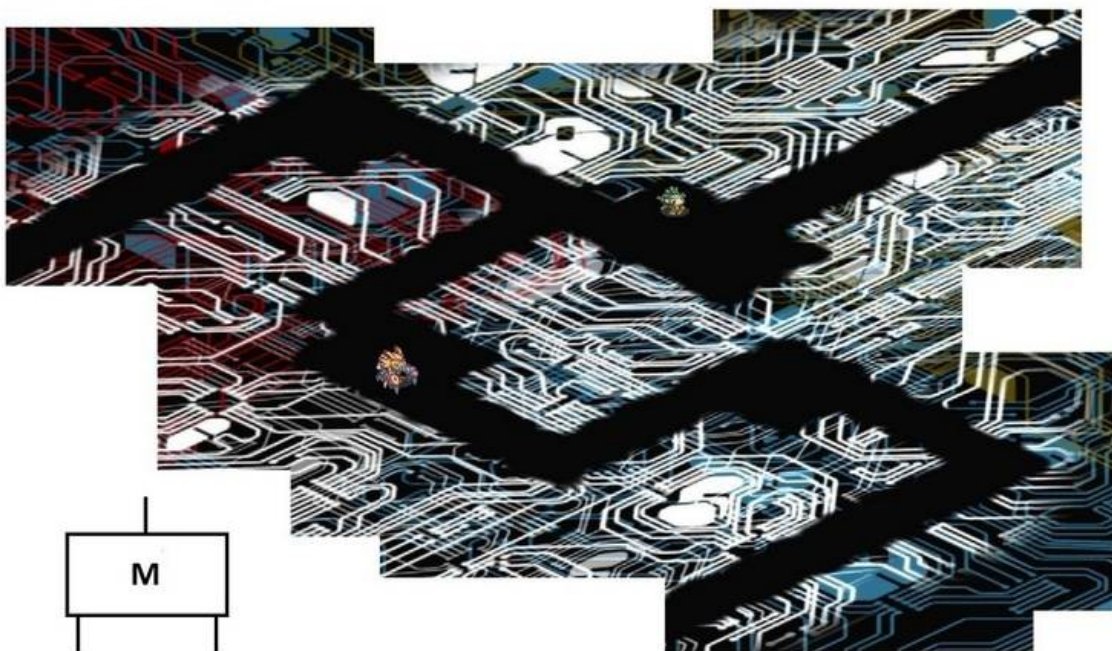

Pattern scenario 2: two paths to north and one path to south

### Table of Contents

1. DW3 Circuit Board Maps
  1. Brief introduction about the maps
  2. The 7 pattern scenarios
  3. The Circuit Board maps

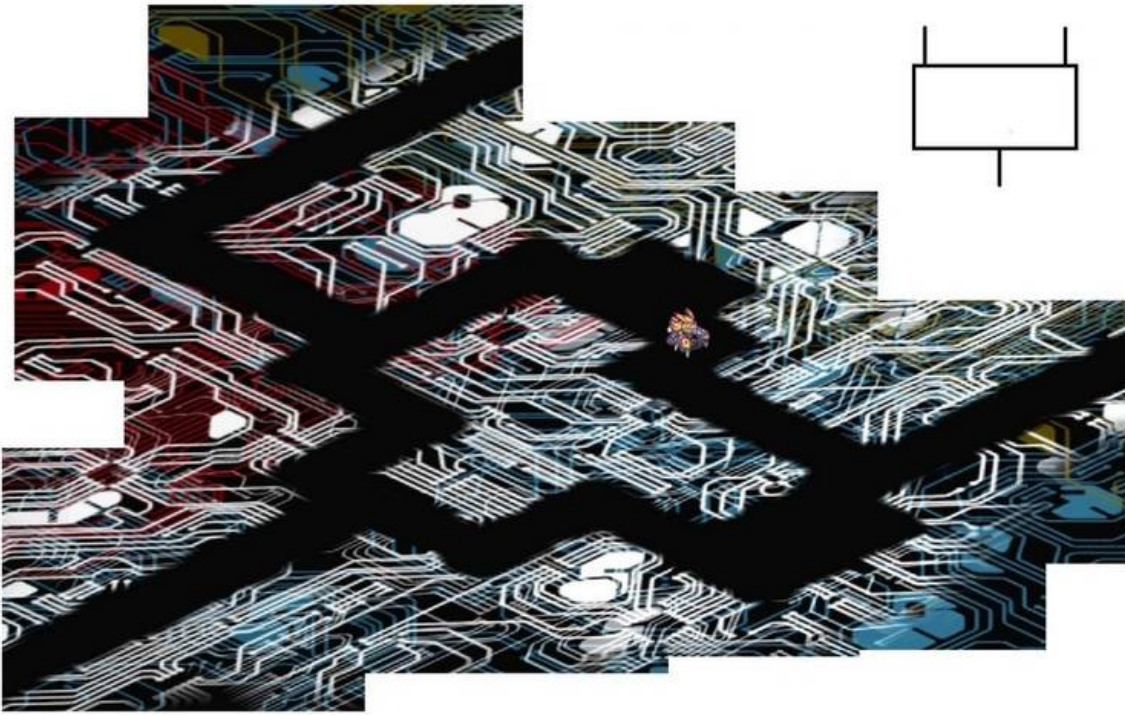

Pattern scenario 3: one path to north and south and two dead-ends

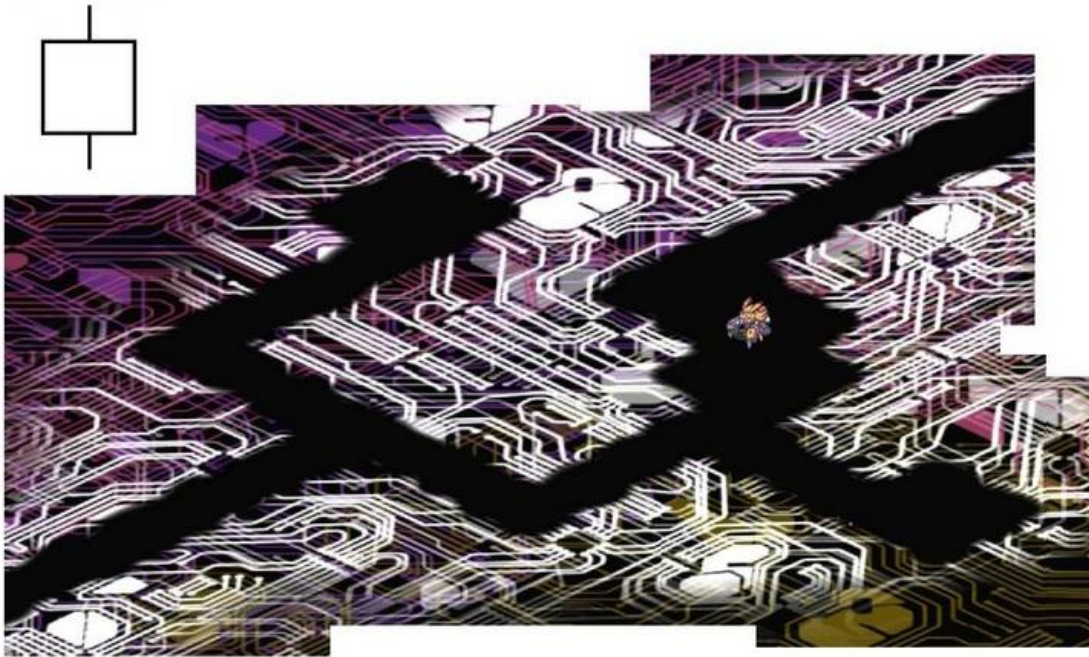

Pattern scenario 4: a hole and a path to south





Pattern scenario 5: a hole and a path to north



Pattern scenario 6: a path from south to a north dead-end



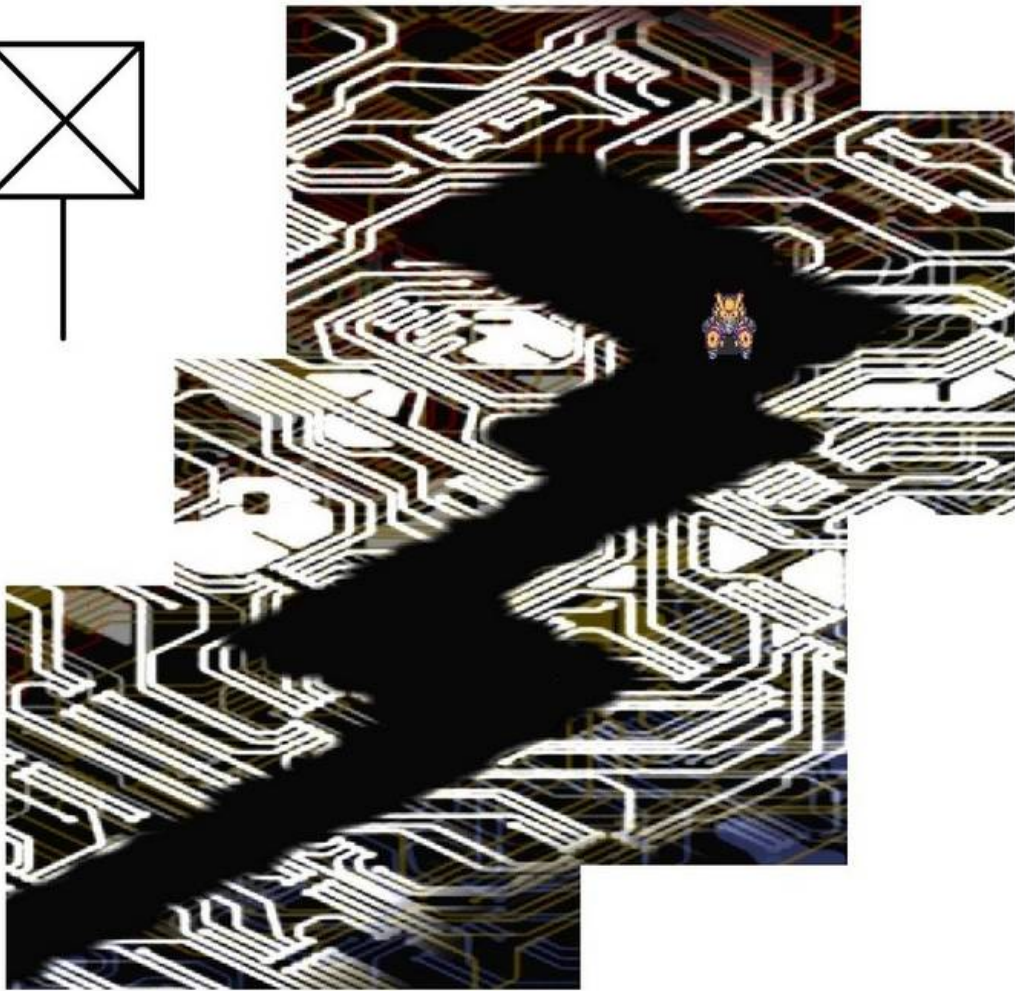
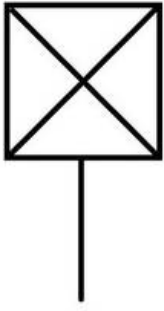

Pattern scenario 7: a path from north to a south dead end

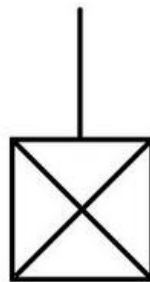
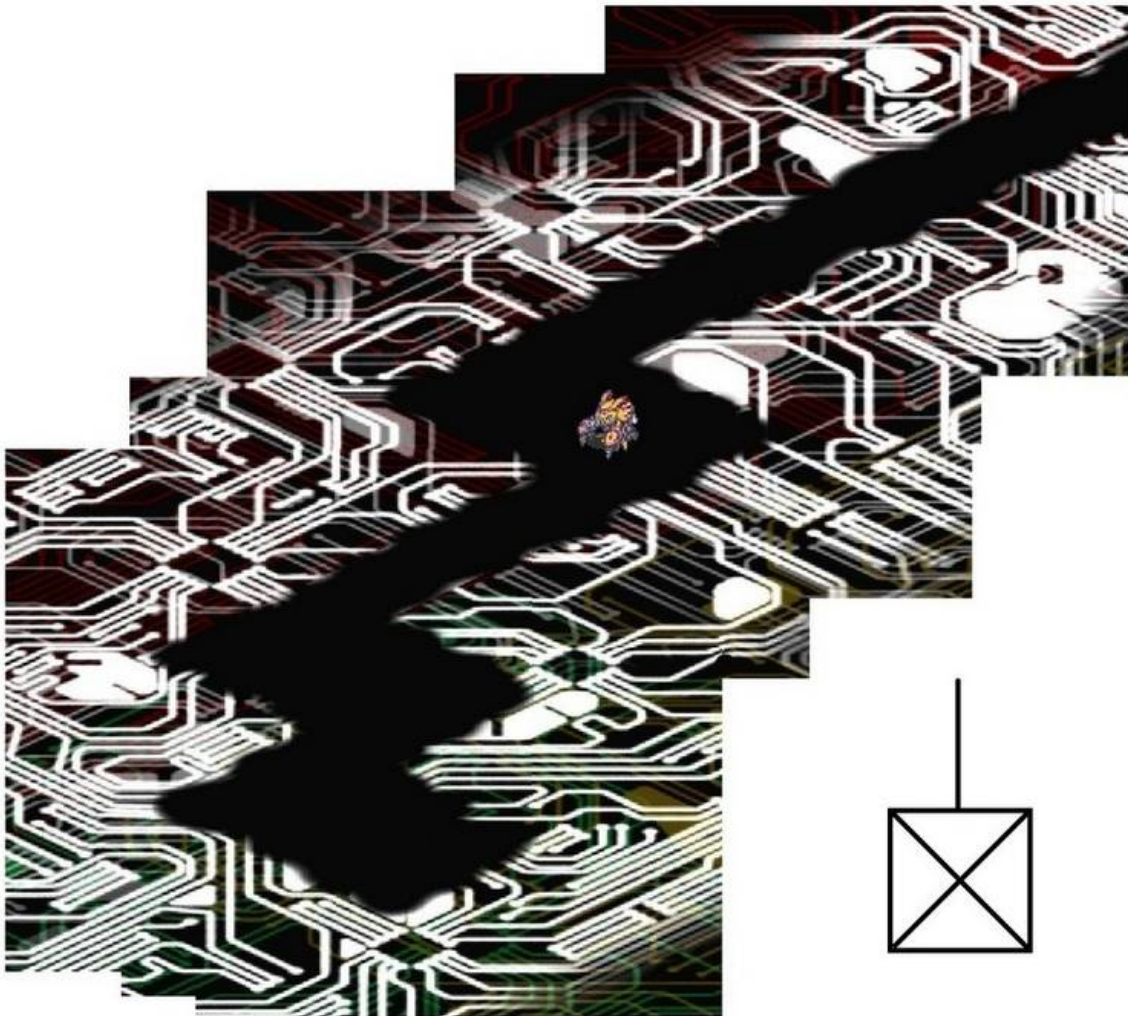

## The Circuit Board maps

---

Finally, here below are the maps. As I said, they were designed connecting blocks, where each block represents a pattern scenario. I hope it was a didactic way of showing them.

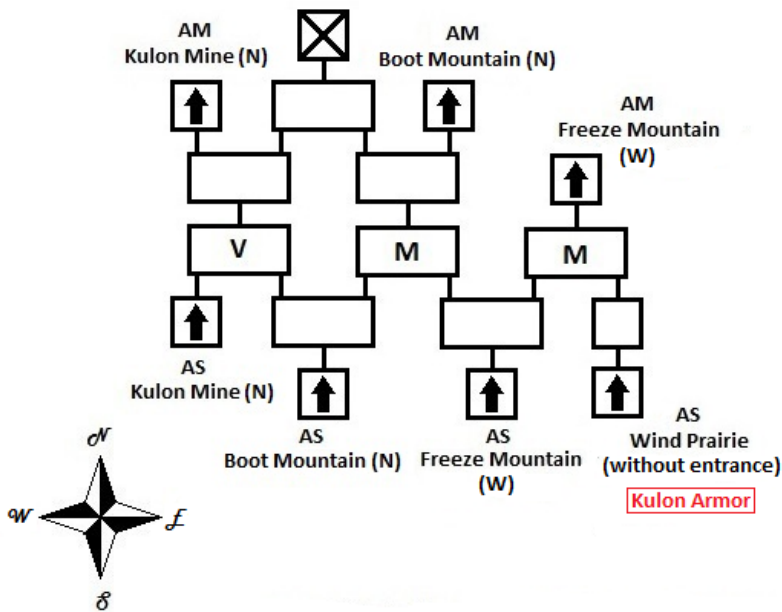
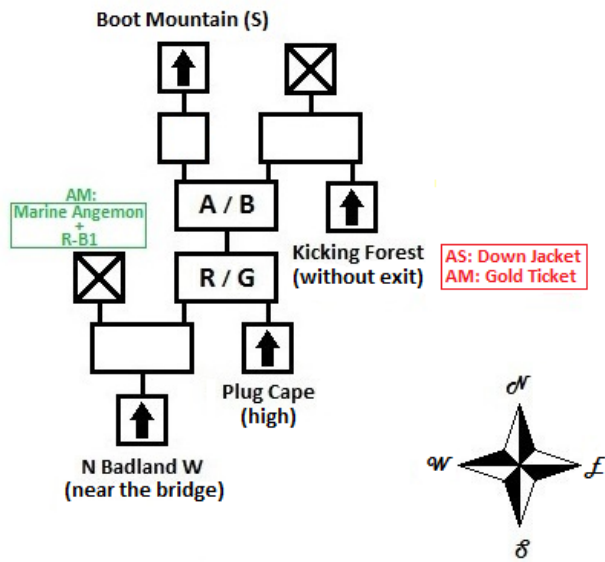
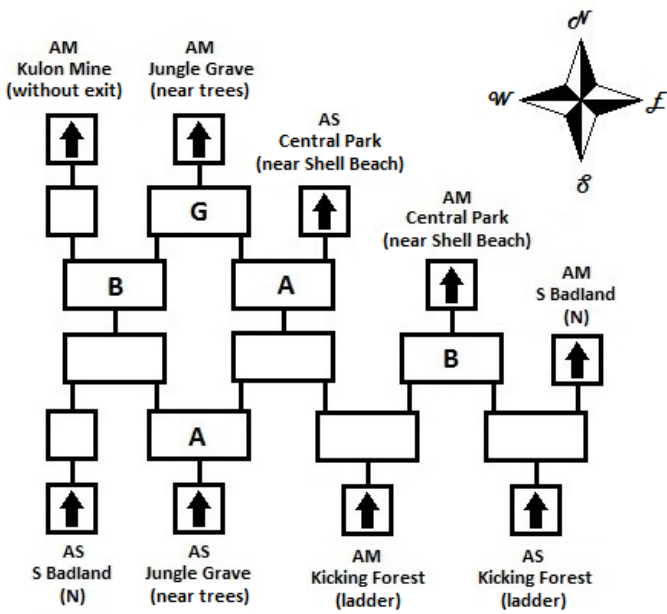

Kulon Mine (W) Freeze Mountain (S)

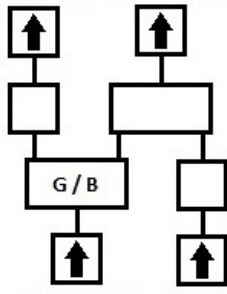

S Badland (S) N Badland E

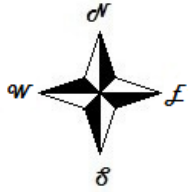

obs: this map is the same for both servers, Asuka (AS) and Amaterasu (AM)

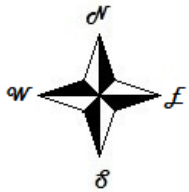
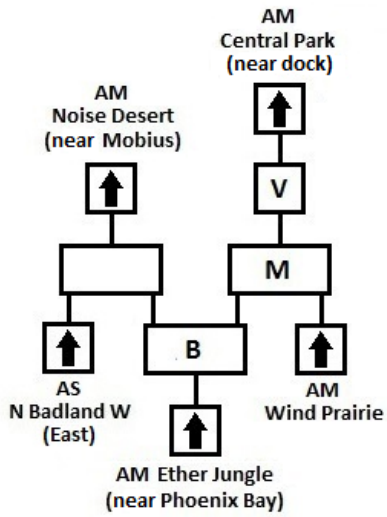

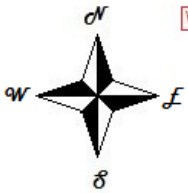
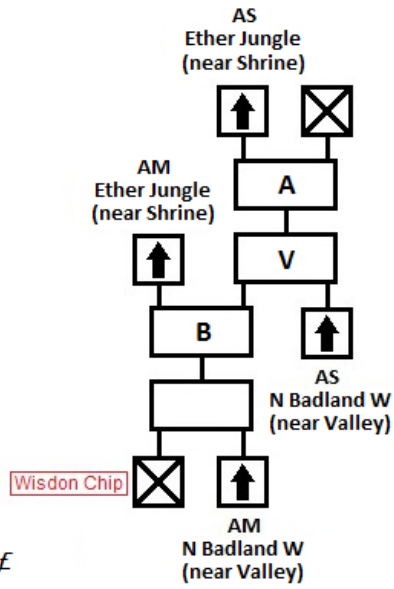
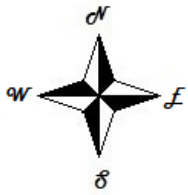
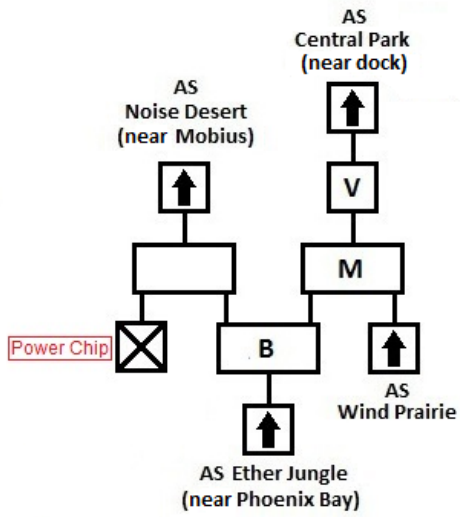



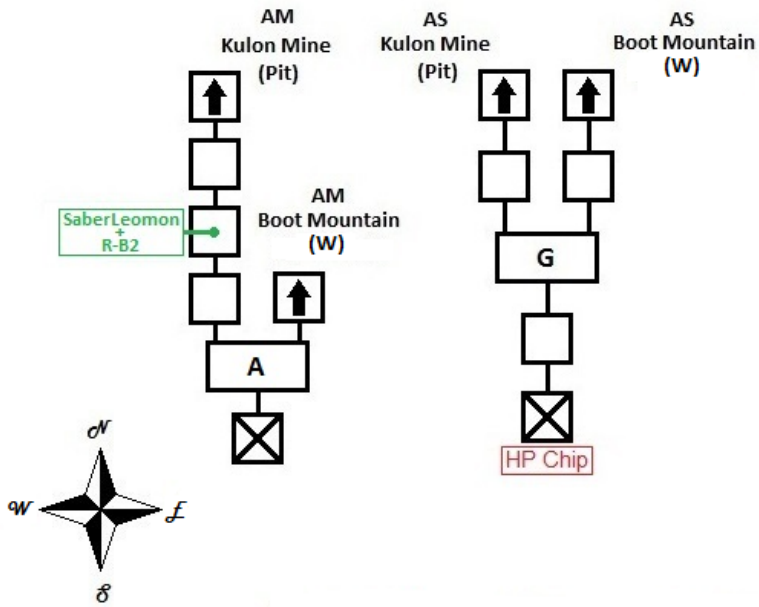
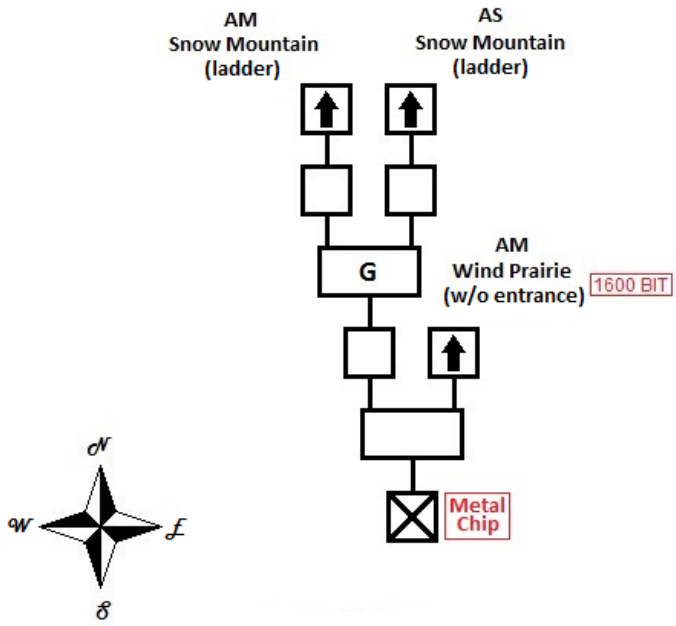

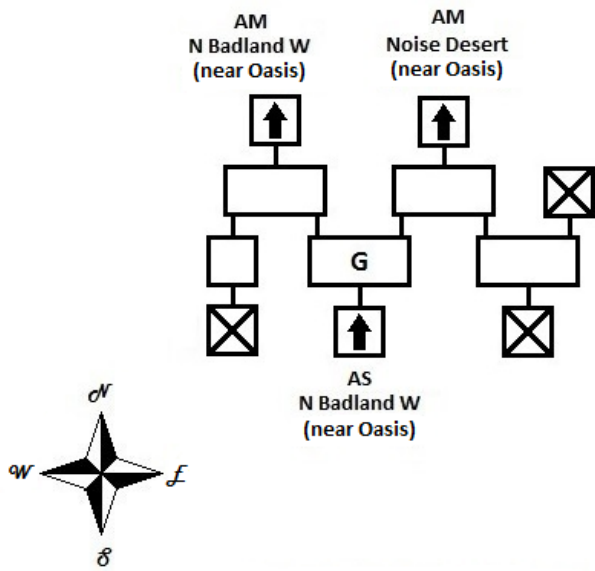
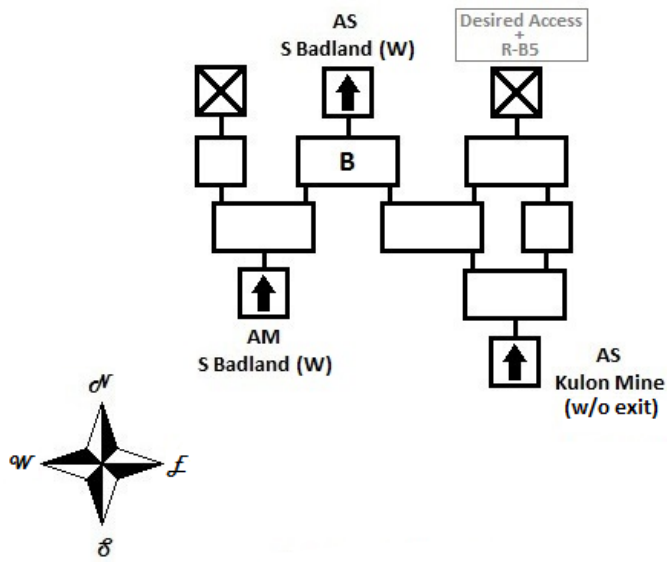

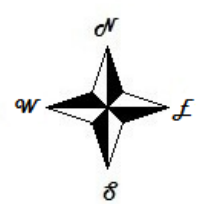
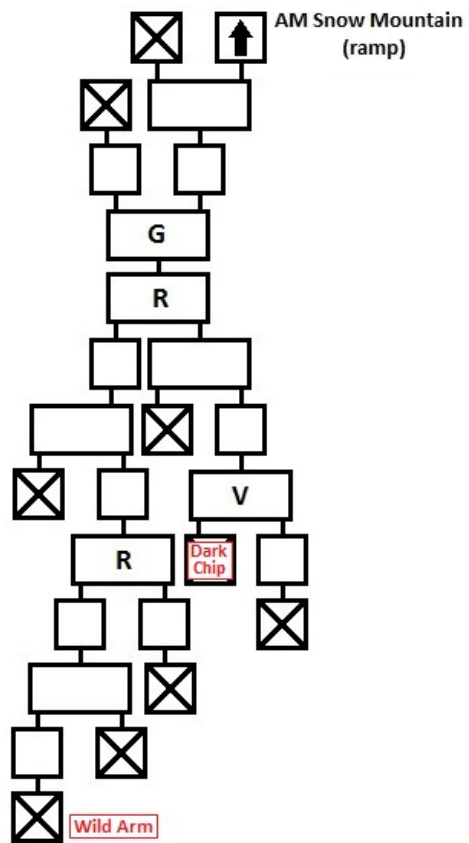
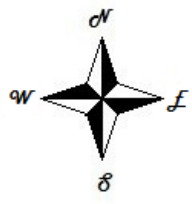
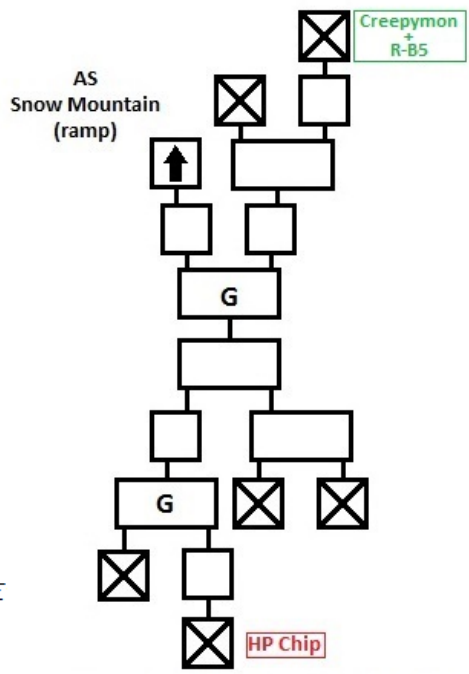



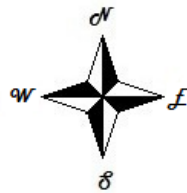
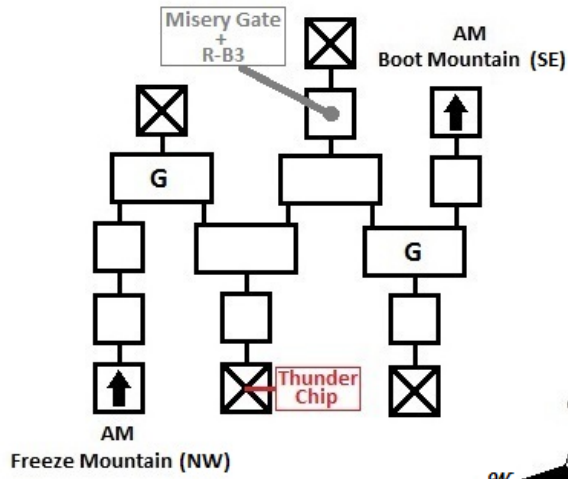
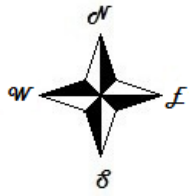
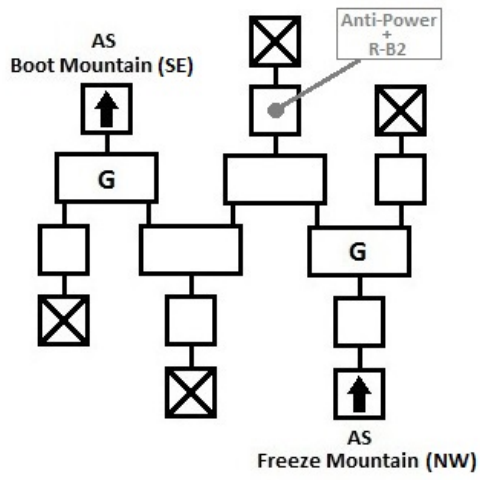

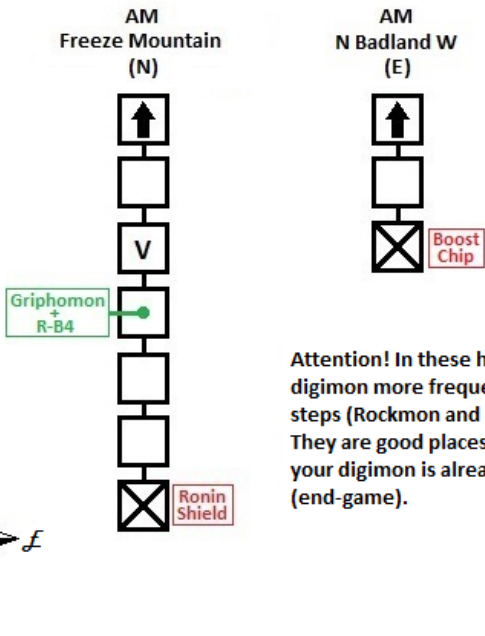
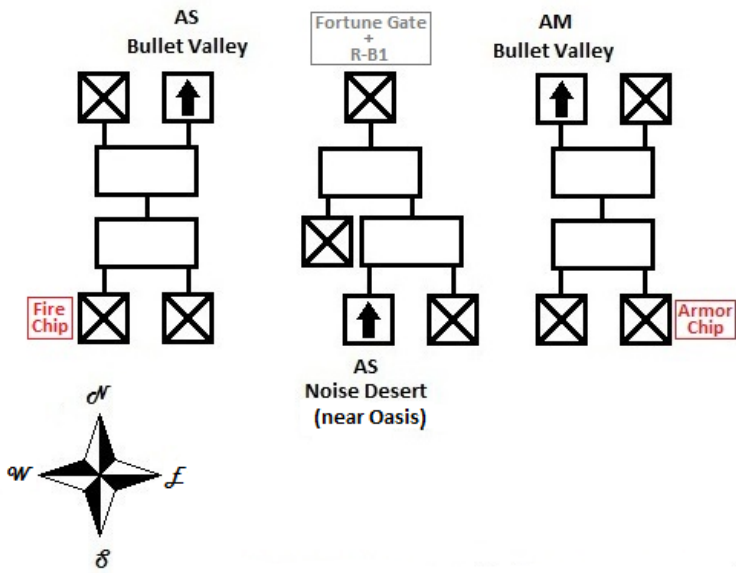

Attention! In these holes appear digimon more frequently with few steps (Rockmon and Drimogemon). They are good places to earn EXP if your digimon is already strong enough (end-game).

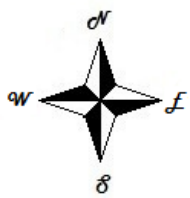
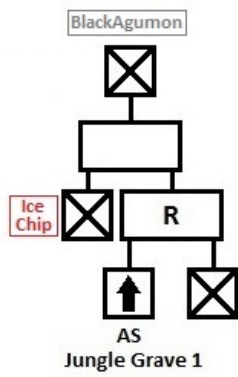
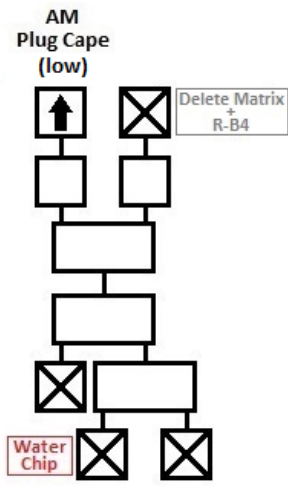
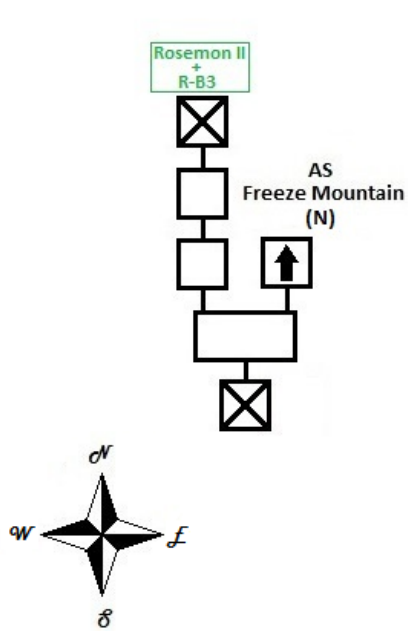

BlackAgumon appears during Etemon's Mic sidequest.



AS  
Central Park  
(near Training)



AS  
Plug Cape  
(low)

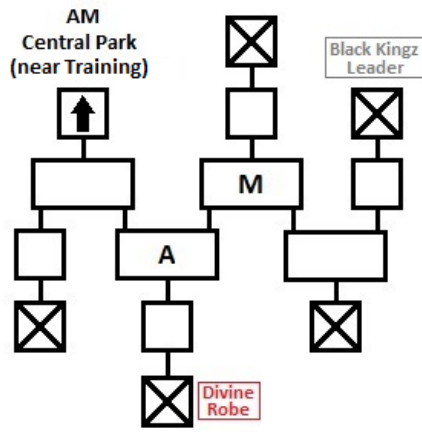
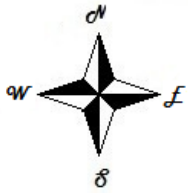
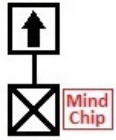

Black Kingz Leader appear during Etemon's Mic sidequest, after defeating the previous BlackAgumon.