

# Resident Evil 2: Dual Shock Edition FAQ/Walkthrough

by Mysticcat

Updated to v8.7 on May 16, 2002

This FAQs/Walkthrough is (c) Copyright 2001 by Phan Nguyen Khanh Dan

```
-----  
### ##### ### # ##### ##### # # ##### ##### # # # #  
# # # # # # # # # # # # # # # # # # # # # # # # # #  
# # # # # # # # # # # # # # # # # # # # # # # # # #  
### ### # # # # ### # # # # # # # # # # # # # # # # #  
## # # # # # # # # # # # # # # # # # # # # # # # # # #  
# # # # # # # # # # # # # # # # # # # # # # # # # # # #  
# # ##### ### # ##### ##### # # # # ##### # # # #####
```

```
#####  
# ##  
##  
##  
##  
##  
##  
##  
##  
#####
```

DUALSHOCK EDITION

```
-----  
Game : Resident Evil 2 Dual Shock Edition  
Platform : Sony Playstation  
Developer and Publisher : Capcom
```

```
-----  
FAQs author : Phan Nguyen Khanh Dan "Mysticcat"  
Email : kthoa@hcm.vnn.vn  
FAQs version : 8.7  
Created : July 11th , 2001
```

## T A B L E S O F C O N T E N T S

- ```
-----  
1. INTRODUCTION  
2. LEGAL STUFF  
3. UPDATE/REVISION HISTORY  
4. CONTROLS  
5. STORYLINE  
6. CHARACTER BIOS  
7. HEALTH GUIDE & HEALING ITEMS  
8. WALKTHROUGH  
  A. LEON A  
  B. CLAIRE B  
  C. CLAIRE A
```

- D. LEON B
- E. QUICK WALKTHROUGH
- 9. FILES
  - A. HINT FILES FOR ROOKIE MODE
  - B. POLICE MEMORANDUM
  - C. PATROL REPORT
  - D. OPERATION REPORT 1
  - E. OPERATION REPORT 2
  - F. CHRIS'S DIARY
  - G. MAIL TO CHRIS
  - H. CHIEF'S DIARY
  - I. INVESTIGATE REPORT ON P-EPLISON GAS
  - J. SECRETARY'S DIARY A
  - K. SECRETARY'S DIARY B
  - L. MAIL TO CHIEF
  - M. WATCHMAN'S DIARY
  - N. SEWER MANAGER FAX
  - O. SEWER MANAGER'S DIARY
  - P. LABORATORY SECURITY MANUAL
  - Q. USER REGISTRATION
  - R. INSTRUCTION FOR SYNTHESIS OF THE G-VIRUS ANTIGEN
    - G-VACCINE. CODE NAMED "DEVIL"
    - FILE LOCATION
    - FILE EXPLANATION
  - S. FILM A
  - T. FILM B
  - U. FILM C
  - V. FILM D
- 10. MAPS
  - SPECIFIC ITEM LOCATION
  - MAP LOCATION
- 11. ITEM LIST
- 12. WEAPON LIST
- 13. MONSTER LIST
- 14. RANKING SYSTEM
- 15. SECRETS
- 16. EXTREME BATTLE MODE
  - A. CHARACTERS & WEAPONS
  - B. STRATEGY
  - C. BOMBS'S POSITION
- 17. HUNK & TOFU SCENARIO
- 18. GAME SHARK CODES
- 19. RELATED RESIDENT EVIL 2
  - A. RESIDENT EVIL 1.5
  - B. BIOHAZARD 2 BETA 1st
  - C. BIOHAZARD 2 BETA 2nd
  - D. RESIDENT EVIL 2
- 20. MISCELLANEOUS
  - CHARACTERS'BEGINNING
  - GENERAL STRATEGY
  - DIFFERENCE BETWEEN LEON & CLAIRE
  - QUICK STRATEGY
  - SPEED WALKTHROUGH
- 21. FREQUENTLY ASKED QUESTIONS
- 22. OTHER STUFFS
  - TREVOR'S NOTES
  - WHERE IS JILL VALENTINE ?
  - WESKER'S REPORT
  - RESIDENT EVIL GAMES
  - MY REVIEW ABOUT THIS GAME

23. AUTHORS'S LAST WORDS

24. SPECIAL THANKS

-----

Okay, let's begin...

\*\*\*\*\*

## 01. I N T R O D U C T I O N

\*\*\*\*\*

Oh no, I have failed a lot in previous FAQs and now I can't fail.

Resident Evil series has passed many adventures :

- Resident Evil 0
- Resident Evil
- Resident Evil 2
- Resident Evil 3 Nemesis
- Resident Evil Gun Survivor
- Resident Evil Code Veronica

The coming arrivals will be Resident Evil Gaiden and Resident Evil 4. In this guide I write about Resident Evil 2.

Resident Evil 2 is considered to be one of the most favourite in series before Resident Evil 3 Nemesis and Resident Evil Code Veronica. Yeah, I confirm that because I also like this game although now it's all. But it still always appears in a lot of Websites and a lot of clubs that means it's very popular. Most of Resident Evil has played Resident Evil 2. But today, I make this guide for Resident Evil 2 Dual Shock Edition—a newer version of popular Resident Evil 2—for everyone : new players or anyone who want to know the difference between the various versions of Resident Evil 2. The versions of this game have changed a lot from the original. This guide can also be used to play ordinary Resident Evil 2 because they are not different so much, except the mini-games. If Resident Evil 1 made a big explosion of horror games so Resident Evil 2 would make it more impressive wonderful...Enjoy !

Any questions about this FAQs, please contact me at kthoa@hcm.vnn.vn.

\*\*\*\*\*

## 02. L E G A L S T U F F

\*\*\*\*\*

I HAVE MADE FEW FAQs AND NOW I STILL KEEP MY OLD DECISION :

- THIS FAQs CAN'T BE REPRODUCED, RE-PRINTED OR ALTERED ANY WAY.
- FURTHERMORE, IT CAN'T BE USED IN ANY KIND OF WEBSITES, COMMERCE, BUSINESS, MAGAZINES ETC OR ANYTHING WITHOUT MY PERMISSION. ALL OF THIS MUST HAVE LAST DECISIONS OF THE AUTHOR ME - PHAN NGUYEN KHANH DAN "MYSTICCAT". PLAGIARISM IS A CRIME WHICH WOULD BE PUNISHED BY LAW. THAT MEANS YOU STEAL MY WORK I HAVE TRIED TO DO.
- IF ANYONE HAVE USED THIS FAQs WITH MY PERMISSION, CHECK IT OUT REGULARLY IN GAMEFAQS. I ALWAYS SEND THE COMPLETE VERSION TO THIS SITE. YOU MUST REVIEW IT AT LEAST ONCE TWO MONTHS.

AS I SAID, I CAN ENTIRELY DECIDE THE FATE OF THE FAQs AS ITS CREATOR. JUST EMAIL ME, LET ME SEE YOUR WEBSITES AND I'LL HAVE RIGHT DECISION. I

ASSURE I'D LIKE TO ANSWER "YES" IF YOU ASK ME. SO DON'T DO BAD THINGS.  
I HAVE TOLD YOU WHAT IS NECESSARY. IF YOU DON'T OBEY THIS LEGAL INFO, I  
MUST USE REAL ACTION.

CURRENTLY THIS SITE IS REALLY AVAILABLE AT :

- [Http://www.gamefaqs.com](http://www.gamefaqs.com)
- [Http://www.psxcodez.com](http://www.psxcodez.com)
- [Http://clubs.yahoo.com/clubs/residentevilunderground](http://clubs.yahoo.com/clubs/residentevilunderground)
- [Http://www.neoseeker.com](http://www.neoseeker.com)
- [Http://www.cheathappens.com](http://www.cheathappens.com)
- [Http://www.cheats.de](http://www.cheats.de)

SORRY FOR BEING RUDE.  
AND THANKS YOU FOR SPENDING READING MY FAQS.

\*\*\*\*\*

### 03. UPDATE / REVISION HISTORY

\*\*\*\*\*

- Version 1.0 (July 11th, 2001)  
FAQs started  
Always has this step...
- Version 1.5 (July 12th, 2001)  
Added "Secrets" section  
Added "Hunk and Tofu"  
This game has many deep secrets which were qualified in Top Gamespot.  
If you don't know all its secrets, you just finish 1/2 the game. Why  
don't we try them ?
- Version 2.0 (July 12th, 2001)  
Added "Hidden Characters"  
Added "Biohazard 2 Beta"  
Another secret about characters. Let's see...  
This is another former version of Resident Evil 2.
- Version 2.5 (July 13th, 2001)  
Added "Ranking System"  
Added and repair "Files"  
No good guides miss these. I also have to make mine more perfect.  
Hope they help you to play better.
- Version 3.0 (July 22nd, 2001)  
Added "Health Guide & Healing Items"  
Repair mistakes  
Added "Vaccine Synthesis" in "Files" menu.  
Added "Maps"  
Many players begin to play this series with Resident Evil 2. So I  
must add the menu about health to show you how to use it. Another  
thing, no good guides could miss "Maps", too.
- Version 4.0 (July 25th, 2001)  
Added "Ammo to kill" in "Monster List"  
Added some maps in "Maps"  
Added "Specific Item Location" and "Map Location" in "Maps"  
Added "File Explanation"  
Repair "Extreme Battle Mode"

Repairing is only an ordinary work of FAQ authors. In the maps, I have added the specific location of items for you to easily play the game. But I also hope you don't use it so much. It spoils your game.

- Version 5.0 (July 28th, 2001)

Added more specific parts in each menu.

Added some new parts of "Miscellaneous"

Oh, this guide is needed to increase very much...

- Version 5.5 (July 31st, 2001)

Added "Game Shark Codes".

This part will make the guide more various...

- Version 6.5 (August 21st 2001)

Added "Other Stuff"

Want to know some secret story parts about Resident Evil series.

Check it out.

- Version 6.8 (August 21st 2001)

Added some important maps

Added a monster in "Monster List"

The "Maps" menu still misses some maps. Now I try to complete them.

- Version 7.0 (August 24th 2001)

Added "Resident Evil games"

Added "Speed Walkthrough"

"Speed Walkthrough" could help you play the game fastest. "Resident Evil Games" might be useful for new players of this series.

- Version 7.2 (August 29th 2001)

Added control types

Added "Review"

Added some missing parts of "Hint Files for Rookie Mode"

This is a special file...

- Version 7.5 (August 30th 2001)

Added some missing files and weapons

Just make guide more complete. This is really a hard work.

- Version 7.6 (September 6th 2001)

Add new site using FAQ with permission

- Version 8.0 (November 4th 2001)

When playing the PC version, I have realized a rather big lack I committed. I have thought that I would stop updating this FAQ anymore, but now the lack is more major than I could leave : missing enemies and weapons. I will cover all of these early or late, then the N64, Dreamcast and PC version FAQs will be done too.

- Version 8.5 (May 13th 2002)

It has been a long time since I marked version 8.0. During that time, I have improved my writing skills thorough many recent FAQs like Fear Effect, Parasite Eve, Devil May Cry, etc. Today, I looked at this guide again, and realized how bad my past writing was. I have tried to fix this guide as much as I can, although I don't have any enthusiasm to repair more.

- Version 8.7 (May 14th 2002)

More info added.

More mistakes fixed.

\*\*\*\*\*

#### 04. CONTROLS

\*\*\*\*\*

~~~~~

##### TYPE A

~~~~~

- Up : forward
- Down : Backward
- Left : turn left
- Right : turn right
- R1 : draw weapons
- Cross : Ok/attack
- Square : Run
- Triangle : Map/cancel
- Circle : menu screen
- Start button : Pause
- Select button : Options
- Auto-aim : Manual

~~~~~

##### TYPE B

~~~~~

- Up : forward
- Down : Backward
- Left : turn left
- Right : turn right
- R1 : draw weapons
- Cross : Ok/attack
- Square : Cancel/Run
- Triangle : Map/cancel
- Circle : menu screen
- Start button : Pause
- Select button : Options
- Auto-aim : Manual

~~~~~

##### TYPE C

~~~~~

- Up : forward
- Down : Backward
- Left : turn left
- Right : turn right
- R1 : draw weapons
- L1 : change target
- Cross : Ok/attack
- Square : Run
- Triangle : Map/cancel
- Circle : menu screen
- Start button : Pause
- Select button : Options
- Auto-aim : Auto

\*\*\*\*\*

## 05. S T O R Y L I N E

\*\*\*\*\*

Over Resident Evil 1, we all know that the S.T.A.R.S. alive members escaped from the incident of the mansion in Raccoon forest which happened by Wesker's cruel plan about T-virus and mysterious corporation named Umbrella. But it's not over yet...

September 29th, at Raccoon city...

A rookie cop named Leon Scott Kennedy, who is a police of RPD department, begins his first day of duty and enters the city. At the meantime, Claire Redfield - a strange young lady enters the city to search her brother named Chris Redfield-one of the survivors of the mansion incident and an important member of S.T.A.R.S. But both of them didn't know something terrible happening in Raccoon... A wonderful city suddenly became a horrible town which is full of strange creatures and mysterious murders. Zombies and some other creatures are around the areas to find human blood. Leon and Claire join together and try to escape.

They have an appointment at RPD Police Station where they thought it was safe...But...

\*\*\*\*\*

## 06. C H A R A C T E R B I O S

\*\*\*\*\*

### ----- LEON SCOTT KENNEDY -----

Found : Resident Evil 2, Resident Evil Gaiden  
Age : 21  
Sex : male  
Height : 178cm  
Weapons in game : Combat knife, VK70 Handgun, Remington M1100-P  
Shotgun, Desert Eagle 50A.E Magnum, Remington M1100 Enhanced, MAC11  
Machine Gun, Rocket Launcher.

A rookie cop of RPD who begins his first day of duty in Raccoon City. He has a wonderful and naive surface but there is an opposite inside his real personality : brave and straight. In the game, he falls in love with a mysterious spy who was sent from Umbrella...

Resident Evil series is a long story built up by roles of a lot of characters. Leon Scott Kennedy is just one of those, and now he is given the main male role of Resident Evil 2. Besides this game, you can meet him in Resident Evil Gaiden for Gameboy Color, and Leon also takes a very small role in Resident Evil Code Veronica though.

### ----- CLAIRE REDFIELD -----

Found : Resident Evil 2, Resident Evil Code Veronica  
Age : 19  
Sex : female  
Height : 169cm  
Weapon in game : Combat knife, Browning HP Handgun, M79 Grenade  
Launcher, MAC11 Machine Gun, Colt S.A.A., Rocket Launcher.

A young lady who loves riding motorcycle. She enters the Raccoon to

look for her older brother - Chris Redfield, who was lost from the mansion incident. On searching, she knows that Chris hasn't been there and decides to continue until she finds him. Claire seems like her brother : violent and freak in behavior. In necessary situation, she becomes a wild woman. But for child like Sherry Birkin , she treats her by a mothering love.

Like Leon, Claire Redfield is considered to be one of the main female characters, and she appears along with Leon in this game. You can find her Resident Evil Code Veronica, where she truly begins to seek her brother Chris Redfield.

-----  
ADA WONG  
-----

Found : Resident Evil 2

Age : unknown

Sex : female

Height : unknown

Weapon in game : Browning HP Handgun

A mysterious spy who was sent from Umbrella. She is half-American, half-Chinese and really a super shooter who has a lot of experience. Although she is thought to be an impersonal and cold woman, she falls in love with Leon. You'll know what will happen to her in the game.

-----  
SHERRY BIRKIN  
-----

Found : Resident Evil 2

Age : 12

Sex : female

Height : unknown

Weapon in game : N/A

A girl child who wanders in the police station. She is the daughter of a scientist who is considered to involve in Umbrella and had died. She was supported by Claire to escape but there is still a secret about this little girl - her pendant.

-----  
\* HIDDEN CHARACTERS  
-----

CHRIS REDFIELD

Found : Resident Evil, Resident Evil Code Veronica

The playable character of Resident Evil 1 and Resident Evil Code Veronica who takes an important role in the game. He is Claire's brother but went away to Europe to investigate about Umbrella. But you can still play as him in mini-game of Resident Evil 2 Dual Shock Edition. As the story of Resident Evil is going, Chris seems to be a very main character. And as I guess, in the future, he will be given more roles, until Resident Evil is ended.

HUNK

Found : Resident Evil 2

The only survivor of Umbrella's salvage team which have a mission to claim G-virus from William Birkin but they got killed by the angry scientist. You also play as him in mini-game.

TOFU

Found : Resident Evil 2

The same as Hunk. He can be the strongest character because he is



very tough. His only weapon is a Combat knife and he is never down when wounded as ordinary characters.

-----  
\* OTHER CHARACTERS  
-----

- ROBERT KENDO -

The owner of the gun shop who you meet first in the game. But he doesn't live longer.

- MARVIN BRANAGH -

He is one of the only surviving police in RPD station. He doesn't live longer, too. You need to meet him to get the key for unlocking doors. But later, you'll fight him.

- BEN BERTOLUCCI -

He is a mysterious person who hides in RPD police station, prison area. Maybe he is there for safety, not prisoner.

- BRIAN IRONS -

Chief, a guy who is considered to involve with Umbrella. He has been working for them and they destroyed his town. He became insane and do freaking work. He killed everyone in his city. But later, he is punished miserably by William Birkin.

- WILLIAM BIRKIN -

He is Sherry's father, a talented scientist who is the creator of G-virus. He builds a secret laboratory area under Police Station to do experiments. He is the target of Umbrella and they want to take his virus because he doesn't give it to them. They send a salvage team to do that and kill William. But before dying, he prompts to infect himself some G-virus and he becomes an insane monster killing everyone who are in charge.

- ANNETTE BIRKIN -

She is Sherry's mother, working as the contact between her husband and Umbrella. She wanders around the Sewer and Laboratory area for something. She won't let anyone to take her husband's G-virus. But in the end, very William kills her.

\*\*\*\*\*

07. H E A L T H G U I D E & H E A L I N G I T E M S

\*\*\*\*\*

- \* USAGE :
- "Health Guide" shows you how to use condition screen
- "Healing items" shows you functions of healing items.
- "Herb Mixing" shows you how to mix herbs.
- "Damage Notes" let you know how strong the enemies'hits are.

```

|-----\
| HEALTH GUIDE \
|-----\-----|-----
-|
| HEALTH      | COLOR      | PERCENT
|
|-----|-----|-----

```

|         |        |           |
|---------|--------|-----------|
| Fine    | Green  | 100%-50%  |
| Caution | Yellow | 50%-25%   |
| Caution | Orange | 25%-10%   |
| Danger  | Red    | under 10% |
| Poison  | Purple | 100%- 0%  |

-----\  
 | HEALING ITEMS |\  
 -----\

-|  
 | First Aid Spray : heal 100% health.  
 |  
 | Green herb : heal 25% health.  
 |  
 | Red herb : (can't be used alone)  
 |  
 | Blue herb : cure Poison  
 |  
 | ~~~~~~  
 ~|

-----\  
 | HERB MIXING GUIDE |\  
 -----

| HERBS                 | COLOR        | HEALING PERCENT         |
|-----------------------|--------------|-------------------------|
| Green + Green         | Green        | heal 50%                |
| Green + Green + Green | Green        | heal 100%               |
| Green + Blue          | Green + Blue | heal 25% + cure Poison  |
| Green + Red           | Green + Red  | heal 100%               |
| Green + Red + Blue    | Grey         | heal 100% + cure Poison |

-----  
 DAMAGE NOTES :  
 -----

NOTES : Combine with "Monster List" will help you to make a good tactics for each type.  
 =====

ZOMBIES :  
 - A bite of a zombie make random damage. Sometimes it only causes "Fine" to "Fine". Just be careful with your health. A bite at neck from the back is often weaker than a bite at neck from the front.

Estimated damage :  
Neck biting : 20-25%  
Feet biting : 5-15%  
Poison breath : 5-15%

-----

#### ZOMBIE DOGS

- A scratch of dog is often half an ordinary bite of zombie. Sometimes one hit is also strong as zombie's. And it can confuse you that you can't determine your target because dogs often attack in multiple.

Estimated damage :  
Scratch : 10-25%

-----

#### LICKERS & SUPER LICKERS

- Your life is always threatened when meeting any kind of Lickers, of course. A simple hit of Licker at your feet just lower one level of your health. A tongue striking is double strong the feet cutting. But...don't be so happy, when you make them furious, just two slices to your head can make you die immediately even you are in complete health. Can you imagine what happen if a lot of Lickers attack you at the same time ? To tell you the truth, you will have no time to shoot them and stand until you die. See "Monster list" and have a good strategy for them.

Estimated damage :  
Feet cutting : 5-15%  
Tongue striking : 20-25%  
Head slice : 25-50%

-----

#### BLACK WIDOWS

- Black Widows attack by dropping Poisonous liquid or striking. Just be careful with the liquid. Its strike makes half damage of a zombie hit. I don't know if it has ever bitten your body like Resident Evil Code Veronica.

Estimated damage :  
Poison Liquid : 5-15% + Poison effect  
Striking : 10-15%  
Biting : 10-25%

-----

#### - HUMANOID PLANTS

Estimated damage :  
Striking : 10-15%  
Poison liquid : 5-15% + poison effect  
Hugging and Poison : 20-25% + poison effect  
Eating head : 100%

-----

#### - G-INFANT

Estimated damage :  
Striking : 10-15%

-----

#### - PARASITE SCORPIONS :

Estimated damage :  
Drain health : 5-15%

-----

#### - SMALL INSECTS :

Estimated damage :  
Bite : 1-5%

-----

#### - SMALL SPIDER :

Estimated damage :  
Jump : 1-5%

-----

- MR.X 1 :  
Estimated damage :  
Punch : 10-15%  
Blow down : 25-30%

-----

- MR.X 2 :  
Estimated damage :  
Simple hit : 10-20%  
Two hits at once : 15-25%  
Full Sequence : 20-50%

-----

- WILLIAM 1 :  
Estimated damage :  
Striking : 15-25%

-----

- WILLIAM 2 :  
Estimated damage :  
Simple hit : 10-15%%  
Full Sequence : 20-50%

-----

- WILLIAM 3 :  
Estimated damage :  
Simple hit : 10-25%  
Two hits at once : 25-30%  
Full sequence : 20-50%

-----

- WILLIAM 4 :  
Estimated damage :  
Thrusting thorns : 30-60%

-----

- WILLIAM 5 :  
Estimated damage :  
Striking tentacles : 10-15%  
Thrusting thorns : 10-25%  
Gulp : 100%

\*\*\*\*\*

## 08. W A L K T H R O U G H S

\*\*\*\*\*

This full walkthrough is for beginners who don't understand much about the game. But I have tried not to let it spoil your game.

About Boss Fight Strategies, I have made an own section in "Monster List". Refer to there for how to beat the enemies.

### \*\*NOTES\*\*

When you grab any new items, especially Key Items, you SHOULD use "Check" command to examine it. After you do that, some item may have another name, which is more correct than the first name you saw before checking it. I mostly use the correct names after checking in the walkthrough, so you should do that either to read the walkthrough more conveniently.

=====

## LEON SCENARIO A

=====

### 1) THE STREETS

~~~~~  
You are in the street. Try to avoid those zombies and get to the only Gun Shop in the corner. You meet the owner of the Gun Shop - Robert Kendo.

After talking to him, grab Handgun Bullets and get out by another door. But in the outside zombies would destroy the glass window and kill Robert. Get back and fight them, and then grab his Shotgun. Then continue your way. You can pass the zombies in the yard and get bullets first. But they will try to get out. Finish them and go to the next path in the yard. Go up and downstairs, run along the path and get out. There are some zombies eating a corpse. If you don't want to make trouble with them, just pass and get on the bus. There are an ordinary zombie and a crawling female zombie. So aim down to shoot it. Get bullets in the bus and get off. If you are good at dodging, just pass those zombies around and go to the gate of police station. There is a hidden green herb beside one of the plants pot. Try to find it. Then get into the station.

## 2) RPD POLICE STATION

~~~~~  
You are in the hall of the mansion. First, go to the furthest door to talk to Marvin Branagh. He'd tell you about the mansion incident, about Chris and other S.T.A.R.S. members. Then he gives you the Blue Card Key. Go out and use the computer. Enter the card to unlock the other doors. Then go to the big door in your right. Prepare yourself here by the item box. There is a locked desk (containing First Aid Spray). You need the Small Key to open it. Go to the next door. You'll see a shadow passing the window. Remember to equip your Shotgun.

## 3) AHHH !!! LICKER !!!

~~~~~  
Turn right. Get bullets from the headless corpse. A lickler is seeing you. No, it is jumping down to turn you into its delicious meal. Okay, use your Shotgun and shoot in calmness. Two correct shots can defeat it. If you feel afraid, try to run pass the monster. But I remind that it will still stay here until you really kill it, because you will pass this place again several times.

Try to find a grey door (File room) which is carved a spade hole beside the corpse. After that, grab the Green Herb and go to the next door. Just go along the path. Get into the red door (meeting room), go inside and find a fireplace. Do you see a picture of hell above it ? Use your Lighter (standard item) and burn it. A Red Jewel will drop. Its name is Virgin Heart. Take it and get outta the room.

## 4) WANDERING IN POLICE STATION

~~~~~  
Go to the last door of the corridor and kill four zombies. Do you see a grey door in the end of the corridor which is carved a diamond hole. Remember it. Then get to the save room (dark room) to save and prepare yourself if you want. Put the Virgin Heart into the item box because you don't use it now. Then go upstairs. You see three statues : the white biggest is holding a Virgin Heart, the god of sun (red) and the

god of moon (blue). Try to find two orange squares on the floor. Then push the god of sun to the left square, the god of moon to the right one. Then you can take another Virgin Heart. Go to the next corridor. Fight three zombies here and go to the S.T.A.R.S. office. Grab the Unicorn Medal and Chris's diary. You can see a picture of S.T.A.R.S. and Chris's results. Open the locker to get the second Shotgun if you want. There is also a First Aid Spray here. Then get out. If you check the corridor, you'll find a locked door which is carved a spade. Ignore it and return to the hall. Put the Medal on the platform of a white woman statue. You'll receive the Spade Key.

#### 5) PLAYING CARDS ??? SPADE, DIAMOND, HEART &...

~~~~~

Go to the door beside the headless corpse. Push the shelf until it's beside the cabinet and climb it, get the Crank. Then next to the door beside the S.T.A.R.S. office, use this key to open it. With your Shotgun, finish the zombies here and get ammo. There is another locked desk needed Small Key (containing VP70 Handgun part). Ignore it and go to the library. First, go upstairs. There is a door here. Don't open because currently you have nothing to do there. Just continue to the end of the way...You are dropped to the below floor. Now see the small picture on the wall and remember the order of the shelves in the bottom. Press the red switch to get out. You'll see that the room looks like the picture with four shelves and a big painting. Arrange the shelves as you saw. The small picture will be pulled down. Grab the Bishop Plug in it. There is a red herb on the table beside the big door. Then get out by that door. Kill the zombies. Run along the floor, put down the ladder and go to the next door. You'll get the Small Key. You only have one. So choose the desk you like to open. Run to the next door. One side of this corridor is being burnt. Go to the other side to the door there. You are in a dark corridor. Get ammo from the corpse and shoot the crows. Be careful ! Four other crows will attack you suddenly from the glass window. Get to the end and open the door. You are on the terrace. There is a burning helicopter and some system of water. First, go downstairs to the courtyard. Fight four zombies and go to the next door. Grab the handgun bullets and Valve Handle. There's another door here. I remind you not to open it you'll get trouble to yourself.

Return, go upstairs and get to the small path beside the helicopter and use the Valve Handle to open water putting out the fire.

Then get into the house and return to the place where half-helicopter was burning. Go to the hidden room (Antique room). You see three statues : the knight between two maidens. Put the two Virgin Hearts on two ladies. You'll receive the King Plug from the knight statue. Take the Diamond Key on the mass beside and get out. Return to the statue room and go downstairs. Use the Diamond Key to open the grey door, shoot zombies here. One of the lockers is Shotgun Shells and a film (You can bring film you collect to the dark room under the stairs). Go to the next door. Grab the green herb and find Marvin. Now he is turned into a dispirited zombie. Use Shotgun to shoot him soon after he rises. Get the Heart Key on the table beside him and get out. You have returned to the main hall. Now go up the steps near the entrance and go to the room on the left. There is a crowd of zombies here. Shoot them. Don't go to the blue door soon. Get to the deeper door. You are in another corridor. There are three doors here : a grey, a blue and a green door. Go to the first grey door by using the Diamond Key. Grab the Cord and Rook Plug. A Licker will destroy the glass to haunt you.

Just finish it by your Shotgun. The interview room (blue door) only has ammo. The green door is locked by Club Key. Okay, get out of this corridor and get to the big blue door. Kill zombies. Go to a small room and open the safe (the code is 2236) to get Shotgun Shells and Police Station map. Then go to the table to get two green herbs. Then run to the inside path. There are two doors. The door beside the corpse takes to the back yard with some green herbs. If you go upstairs, you'll find a door which is locked inside. Don't worry, it only takes you to the dark corridor you have already searched. So you choose the brown door which is locked by Heart Key. Open it. Put the Cord on the system which has the green light. Some shutters will cover the broken windows. This work is free that you can do or not. But later you'll understand why I remind you to do it. Get the Shotgun Shells beside the stairs. Then go downstairs.

#### 6) BASEMENT...AND CLUB KEY

~~~~~

Finishing the three dogs. In front of you, the Autopsy room is locked with Clug Key. If you go to the old door in your left (Leon's left), you only get a red herb and nothing to do. Because this place is for Claire. Yours is the parking lot. So get out of here and reach the parking. Before going to it, go to Power room (red door). Grab a green herb and find the main system to put the switches to supply electricity to the Weapon storage. The order is 3 up and 2 down anyway. After that, reach the parking lot in the end of basement corridor. Just go...

After talking to Ada Wong, get the green herb in the corner and help her to move the lorry aside. Then get to the secret door with her. When she goes, follow her to the sliding door to the prison area. There is a white door on your way but now it's not time to open it. In the prison, talk to Ben Bertolucci to know what is happening. Then grab the Manhole Opener on the shelf. Go to the white door I said. There is a red herb beside the wall and two dogs locked in the cages. If you really want to get the herb, try to shoot the dogs from outside or they will scratch you when you take it.

Use the Manhole Opener to open the lid on the floor and climb down the ladder. Pass the Black Widows and go upstairs. Go to the save room and prepare yourself. Then get to the next room and put on the door all the plugs you collect. Now you only miss the Knight Plug. When going out, Ada will appear. Now help her to go through the upper hole. You'll control of Ada. Go out and kill the dogs. First, go down the right lift to get Shotgun Shells for Leon. Then go to the left door, grab the map and go down the steps. Push the three boxes into a line appreciate with the passing space. Then go up and operate the system. Get pass the boxes and grab Club Key. Then return to the place where you have passed the hole. Ada will throw ammo and the key to Leon. Return to Leon and go down the stairs, climb up the ladder. Try to return to the Autopsy Room, using the Club Key. Ignore the corpses and the dropping lid, just take the Red Card Key. After that, they will wake up to attack you. Finish them and get out. Use the Red Card Key to open the Weapon storage. Get ammo and check the locker. There are two things : Machine Gun and Side Pack. I think the Machine Gun is necessary for you later. The Side Pack, you can get it or let it to Claire. Are you ready ? Get out and go upstairs.

Use Club Key to open the door you first see beside the stairs. Get ammo in the locker and the Magnum beside the corpse. Get out and return to the corridor where there is a green door. Open it with Club Key. You

are in the TV room. Pay attention to the white picture with the wheel. Then go to the other side. You see three faucets as three women relieves. First, kindle the column in your left. Then burn the faucets in the order 12, 13 and 11. You'll get the Cogwheel from the picture. Get out and return to the library. Now go upstairs to the door that you didn't go. You are in the 3rd floor. Go to the next door, check the place, use Crank on the square hollow to make a new stairs. Go up on it and put the Cogwheel to the machine. A secret hole is opened. Grab the Knight Plug on the wall and get down the hole if you like. After hearing Ben Bertolucci's cry, go there and talk to him. He was killed by William Birkin.

When Ada goes away, return to the room where you put the plugs, remember to bring your Machine Gun. When you reach there, a strange creature attacks you. Maybe it was born from some body part of monster William. It attacks you by coughing out the scorpions which climbs your body to get blood. Don't let any of them on your body. Aim down your Machine Gun and shoot continuously. Don't stop. If you are not familiar, just keep your R1 until it runs out of ammo. At that time, the monster is certainly dead. Put the Knight Plug and get into the new door. Take Ada with you.

#### 7) SEWER

~~~~~

Get to the Control Room, save here if you want and remember to bring the Valve Handle with you. Try to push the white locker aside, you'll find a warehouse that contains weapons and ammo. Climb down the ladder, use Lighter to kindle the light to get ammo. Then climb up and go down the lift. Leon would be shot by Annette. You, Ada must chase after her. Follow her until you come the sewer paths. Then climb up the ladder. Try to avoid the insects and go down...

After talking to Annette, pass to the other side and climb down another ladder. Something wrong...

Return to Leon. Go to the way that Ada did. But now you can't climb up the ladder. So you must go along the path. Go to Leon's left first, climb the steps and check the corpses. You'll get a Wolf Medal and Shotgun Shells. Now go straight the path until you see a fork road with the black widows, turn left (Leon's left) and go through the door. Continue to run til you see a big door on the left. Climb the step and open it. You can't pass to the other side without a bridge. So use the valve with the system on the right to pull down the bridge. Go pass. Get herbs and Shotgun Shells. Here there is also the similar system to control the bridge. Use the valve here to pull it up. Later you will know I remind you to do this. Then get into the next door. You are in a long corridor. Just go along it. Try to find a gas cylinder in your left when going. Until reaching the end, you'll find Ada shooting something in the water. A giant alligator...Run ! Run like hell !!! Run to the gas cylinder, press the button to drop it. No ordinary weapon can take wipe of this thing. Wait until the alligator bites the cylinder, take your Shotgun and...Splashhh !!! It's funny to see a headless alligator. Okay, meet Ada and talk to her...

After that, go up the ladder and pass the bridge (do you understand why you must pull it up ?). Check the corpse and get Eagle Medal. Now return to the black widow path. Do you see some system in the right ? Yeah, put the two medals on it. Then the waterfall will stop and you can go through the secret door.



## 8) FACTORY AREA

~~~~~

Get the train and go on. William will play a mini-game with you here. Just shoot his hand. But if you don't want to lose ammo, just run around and let Ada handle it.

Get off the train. Then go to a corridor. Shoot four zombies. In the fork road, go north and turn right, get the Shotgun part from the corpse and combine it with your Shotgun. You'll receive Enhanced Shotgun. Run south, turn and go to the next corridor. Fight four zombies, too. Go north to get herbs, then run to south and climb the ladder. Remember to remember your weapons and ammo here. Then get out of here. You'll see another train. First, go to the train to find the Control Panel Key. Then get out, put the key to the table beside the train to activate. Both you and Ada get on the train. William wants to joke again. If you are new to this game, I advise you to use the Magnum because it's faster than heavy Shotgun. Reload your gun each time it runs out by menu screen. Don't let your character reload it himself because it's a waste of time while William continually beats you. Heal your health frequently, don't wait until it's Danger because the boss can move his claws through your abdomen anytime. After a while, William would be wounded and run away. Return to Ada.

## 9) LABORATORY AREA

~~~~~

After talking to Ada, prepare yourself in this infirmary and get out.

Remember, you can't open the north elevator because it's checked by Claire. Now go to the west to a fork road corridor. Your way you standing is showed by the white light. You'll see two other ways which one is blue light, one is red. The blue is the west area. The red is the east. Then pay attention to some system in the center of the position you are at. It needs the Main Fuse to supply power. First, go to the west area, turn left to the fusion room (full of fog). Grab the F.Aid Spray and Fuse Case. Use this thing with some machine in the right. It is changed into Main Fuse. Use this to put on the system I have said. The electric power is supplied. Now go to the east area. First, turn left to the last room (Researcher's room), get the Flamethrower and shoot the roots, only one little shot. Then equip your Shotgun and pass the hole. Finish two Lickers. You'll get two boxes of Shotgun Shells in the locker. Then get out.

Now go to the left, put the switch to open the shutter. Finish the Plants by your Flamethrower. Notes : this weapon is only effective in close distance. Okay, go out, kill another plant and climb down the ladder. Go into the Licker corridor. Don't run, just go in calmness. Once you turn right, another Licker will jump down from the air. Just take wipe of it by your Shotgun and kill two others. Grab green herbs and go through the left path to Monitor Room. Save here if you want. Then go to the next path. There are two rooms. First, go to the left room (Leon's left). It's William's experiment room, grab First Aid Spray and kill some Researcher zombies. Take the Lab Card Key and get out.

Now you can go to the right path (be careful with some dropping worms from the ceiling), use the card to open the door. This room is not necessary to go. Let me explain about it for you

-----

--

ADDED NOTES :

When you go here, fight a huge moth. Operate the computer and enter the password "GUEST". Do you remember the right shutter of the west area ? Put the button to open it. You'll find another door and a table in front of it. It needs two different fingerprints to unlock the door. After you enter the code of the computer. You can go here to enter your fingerprint, then get out. After that, if you play the 2nd scenarion, Claire will enter hers and go into the room. This room only has a Machine Gun and...three Lickers. You also find out this is the place to do experiment and create Lickers.

-----  
--

Return to the west area, using Lab Card Key to open the first door. Grab the MO disc. Nothing else here except for ammo and some crazy "researchers". In this episode, you'll see a scene about Annette and Ada and find the truth about Ada's mystery...

Head to the east area to the Licker corridor, use the MO disc to open the shutter in the right. Go to it and prepare for your final battle

#### 10) ESCAPE

~~~~~

Push the red button to operate the elevator. But you must face William again before getting out. Okay, four Magnum shots can wound him. After that, he has something wrong and changes into an unshape creature. Now it's really dangerous because he continually jump in the air everywhere. Just run around the room until he jumps to you and give you a big damage (heal your health soon). Then try to aim correctly and shoot him before he jumps away. Six or seven Magnum shots and defeat him.

Huff...Go down the elevator and get out of this hell. See a wonderful FMV...

-----END OF LEON SCENARIO A-----

=====

#### CLAIRE SCENARIO B

=====

#### 1) COURTYARD

~~~~~

Now you are on the street. Just avoid those zombies and get to the gate. You're soon at Police Station courtyard. Go to the guard room on the south to get Cabin Key and open the north door. Now you can't get here anymore because of the zombies. Get ammo and stuffs here. Then reach the next door. Fight the zombies and go upstairs. You'll see a FMV about the burning helicopter. As the first person who witnessed the event, you must put out the fire.

#### 2) RPD POLICE STATION

~~~~~

Get to the dark corridor, grab the Green Herb and shoot the crows which are eating a corpse. If you are new to this game, go to the brown door first and go to Waiting Room (save here soon). Reach the Main Hall by the next door, put the button to pull down the ladder and descend, remember to get the Unicorn Medal at the end of the 2nd hall. Grab the Grenade Launcher on the table. Then return to the dark corridor.

Unlock the blue door, grab some Green Herbs and go downstairs to a

room which is full of zombies. Get the Valve Handle, go to the small office room and open the safe with the code number 2236. You receive a map and Acid Rounds. Return to the heliport and use the Valve Handle to put out the fire. Get another Acid Rounds in the helicopter. Then go in and see a FMV...another boss...

### 3) NEW BOSS - MR.X

~~~~~

When you come in, you fight him soon. I call him Mr.X - a kind of Tyrant. That's the reason why I remind you to get the Grenade Launcher first although it wasn't necessary at that time. You can use Grenade Launcher or Handgun to take him out. After that, return to the room where half-helicopter was burnt. Mr.X wakes up...

-----  
--

#### ADDED NOTES :

Each time Mr.X is down, he remains for you some kind of ammo. So don't miss them. Collect the stuffs from his lying body. If you leave the room where he is, you won't have chance to get the stuffs anymore.

-----  
--

### 4) WANDERING

~~~~~

You'll hear someone's cry from the destroyed door. But now you can't go to it. Go to the deeper room to get the Blue Card Key. A Licker will jump down after you get it. Don't move and shoot it by Acid Rounds. Your moving action can make it furious and slice your head if you don't shoot promptly. Get out and go to the main hall on 1st floor. Use the card to unlock all the electronic doors. Go up to 2nd floor and go to the library. Solve the puzzle here as Leon did, you'll receive Serpent Stone. Then get to the next room. Use Lockpick to open the desk to get Flame Rounds. Kill the zombies. Then go to the S.T.A.R.S. office and talk to Leon. After that, grab Diamond Key on the desk. Open the locker to get the Bow gun. Get "Chris's diary" and "Mail to Chris". When you get out, you'll see Sherry. But you don't touch her now. Just reach the north and go to the statue room. Solve the puzzle and get one Virgin Heart. Then go downstairs. Get to the save room to save if you want. Use Diamond Key to open the grey door (locker room), use lockpick to take the Bomb in the last row of lockers beside the next door. Then get to Marvin's place. Grab the Detonator and combine with the Bomb. You'll receive Bomb & Detonator. Then get out to the main hall. Put the Unicorn Medal on the woman statue to get Spade Key. Go to the left big door, shoot zombies here, use Lockpick to open the locked desk to get an item. Reach the next door until you are at the grey door beside the headless corpse, using Spade Key to open it. Get inside and take the Lighter. Reach the next corridor to the meeting room. Use Lighter to get Virgin Heart.

Return to the Antique room, put the Virgin Hearts to the two ladies to get the half-Jaguar Stone (Blue Stone). After that, use Bomb & Detonator to make explosion at the destroyed door beside the helicopter and get into it, hear Chief Irons tell you about the incident here...

After that, reach the Tiger corridor to a decorated room, turn on the

switch and talk to Sherry...

There is a First Aid Spray in the box. Take it if you want. Then return to where Brian Irons was. He was away remaining the Heart Key. Take it and return to the main hall. Go up the steps near the front door and go to the left small door. Shoot zombies here. Don't go to the big blue door soon. Go to the deeper corridor, use Diamond Key to open the grey door and grab Eagle Stone. Don't get the First Aid Spray or it will be a waste of time with the Licker. Then get out and go to the big blue door, use Heart Key to open the way to basement.

#### 5) BASEMENT

~~~~~

Leon "invades" the parking lot. So yours is the area in the other side. At the fork road, turn left (Claire's left) to a dirty area. Fight the dogs and climb down the ladder. Go to the save room and prepare yourself. When going out, you'll meet Sherry. She will pass the hole to bring you the Club Key. Now take control of Sherry and begin mission.

Try to avoid those annoying dogs. First, go to the room where Ada was in scenario A to get ammo for Claire. Then go to the water room and solve the puzzle as Ada did. Then pass the bridge and grab the key. Return and throw those things to Claire.

Take control of Claire. Go up the ladder and return to the corridor. Fight the zombies and get to Autopsy Room to get Red Card Key (There are Lickers here, not zombies). Then go to Power Room to supply power and take the map. Use Red Card Key to open the Weapon Storage. Grab ammo around. The items in the locker depend on what Leon got. If you let Leon got all Machine Gun and Side Pack, now Claire would have nothing to get. Go to the parking lot to the prison area to get bow gun arrows. Then go to the dog cage area to find the Crank. After that, return to the police station.

#### 6) RETURN TO POLICE STATION

~~~~~

Use Club Key to open the door beside the stairs only to get Acid Rounds. Then take the key to open the TV room, solve the puzzle of the faucets. Mr.X comes again. Just do your best with your Grenade Launcher. Five or six correct shots can make him down. Get the G.Cogwheel and get out. Mr.X appears again in the corridor. Take him off and go to the 3rd floor. Use the Crank to make a new way and operate the system by G.Cogwheel to get another half-Jaguar Stone. Combine it with the one you had to make a complete Jaguar Stone.

When you open the door to Library, Mr.x still wants to tease you. And you just reply him by your talent in shooting.

Return to Irons's room. Sherry is here. Find a picture behind Irons's armchair, turn the switch and put the three stones on the hollows. Get the "Mail to Chief" and get down the elevator. Reach the Chemist room and talk to Brian Irons...

After he got killed miserably, get Acid Rounds in the left and climb down the ladder. You'll meet the first form of William Birkin. Currently he isn't changed so much. Keep a safe distance, using Grenade

Launcher to shoot him. He is holding a bar and never let him beat you by it. You'll be shocked heavily and hard to continue the battle. Just four and five hits can make him weak and drop away. Return to the elevator to take Sherry with you. Then reach the area William was, put the switch to pull down a ladder and climb up.

#### 7) SEWER

~~~~~

After meeting Mr.X in a sight, Sherry will be dropped down by a drain. Take control of Claire and continue the game. Go to your Control Room. Use Lockpick to open the warehouse, climb down it to get ammo if you want. Now get down the lift and talk to Leon. From here you can also reach Leon's control room in the other side (Notes : Only the characters in scenario B could go to the other control room ).

Okay, head to the sewer path. Go north and check the corpse to get Wolf Medal and ammo. Then turn left (Claire's left) to another path. Go to the left door (talk to Annette) and use Valve Handle to pull down the bridge. After passing, pull it up and go to the "alligator hall" (there's no alligator in scenario B). Climb up the ladder, passing the bridge and take Eagle Medal. Get out of the area to the sewer path, put the two medals on the machine and run through the door in the waterfall. You'll meet Sherry here. Let's get on the train.

#### 8) FACTORY AREA

~~~~~

In the first corridor, kill four zombies, find the corpse to get Spark Shot if you want. Do the same in the 2nd corridor, then get up the ladder. Take control of Claire only. Prepare yourself here. Then get out. There's no train. Try to find a small lift and go down to the Control Panel Room. Take the C.Panel Key and fight Mr.X.

In the save room, put the key on some machine on the right. Then go out, activate the train on the table and get on. Ready to enjoy another play of William.

In this battle, I think the best weapon is Grenade Launcher with Flame Rounds. You can use Spark Shot but I see this thing is almost slow and useless. Try to heal your health frequently. This 3rd William always use sequences of hits to attack that make a lot of damage. So be careful.

#### 9) LABORATORY AREA

~~~~~

Leave Sherry and go through the hole outside. You are dropped into inside of the north elevator that I said in Leon scenario A. Sherry is being brought to the lower area.

Go into the Pump Room, use the big lift to get down. Do you see a box that you can push here ? You'll use it later. After getting down, get ammo beside the typewriter. Then use the small lift in the right to get down. Shoot the Lickers, then put the switch to supply power to the elevator. Now you can get out of here by using it. Kill the naked zombies and go to the right way to the main area. As Leon, go to the west area first, getting the Main Fuse to supply power. Then go to the east, grab ammo and Lab Card Key from the Researcher's room and open the shutter in the left. Use Flame rounds to take off the Plants. Go out and descend the ladder. Go to Licker corridor, get green herbs and

head to Monitor Room and pass it, too. Use Lab Card Key to open the moth room and enter the password "Guest" again if you like.

-----

--

ADDED NOTES :

With this work, you can return to the west area and enter the 2nd fingerprint to get into the Licker experiment room.

-----

--

Go to William's experiment room, get the Power Room Key and go out...

After meeting Annette at the Monitor room, return to the elevator and go down. In the Pump Room, push the box on the lift. Then get down with it. Remember to make necessary space to push. Move to the right, then to the north until it lies beside the others. Climb them and get to Power Room to save Sherry...

The warning about explosion appears. Return to the west area to find Sherry. Get the Master Key from Annette's corpse, using it with the elevator to go down the railway to escape by train.

10) ESCAPE

~~~~~

Go to the end of the train to save and get Platform Key. Get off and open the gate. Passing the steps to other pavement, put the machine to get Joint S Plug and Joint N Plug. Go to the next room and put them all in their place. After that, Mr.X appears again. This time, none of your weapons can take him off. Try to run, run like hell, sometimes shoot. Until 3 minutes are over, Ada appears to throw you the Rocket Launcher. Use it to play the finishing touch with this boss...

Okay, return to the train, shoot the naked zombies and operate the machine in the north to open the gate. Then get on. See a FMV...

After the incident, go to the back of the train. You'll fight the final sharp of William Birkin which is now an indefinite creature. This boss is not hard. Just try to shoot fast, as fast as you can that doesn't let it close you. Then get out and see the FMV ending...

-----END OF CLAIRE SCENARIO B-----

=====

CLAIRE SCENARIO A

=====

1) THE STREETS

~~~~~

You are in the street. Try to avoid those zombies and get to the only Gun Shop in the corner and meet Robert Kendo. After talking to him, grab Handgun Bullets and get out by another door. But the outside zombies would destroy the glass window and kill John. Fight them, and then grab his Bow gun. Then continue your way. You can pass the zombies in the yard and get bullets first. But they will try to get out. Finish them and go to the next path in the yard. Go up and downstairs, run along the path and get out. There are some zombies eating a corpse. If you

don't want to make trouble with them, just pass and get on the bus. There are an ordinary zombie and a crawling female zombie. So aim down to shoot it. Get bullets and get off. If you are good at dodging, just pass these and go to the gate of police station. There are a hidden green herb beside one of the plants pot. Try to find it. Then get into the station.

## 2) RPD POLICE STATION

~~~~~

You are in the hall of the mansion. First, go to the furthest door to talk to Marvin Branagh. He'd tell you about the mansion incident, about Chris and other S.T.A.R.S. members. Then he gives you the Blue Card Key. Go out and use the computer. Enter the card to unlock the other doors. Then go to the big door in your right. Prepare yourself here by the item box. Use Lockpick to open the desk. Go to the next door. Remember to equip your bow gun.

## 3) AHHH !!! LICKER !!!

Turn right. Get bullets from the headless corpse. A licker is seeing you. No, it is jumping down to turn you into its delicious meal. Okay, use your Bow gun and shoot in calmness. Bow gun is a long range weapon that splashing arrows in a line. So try to wait until the Licker comes close you and shoot down. Two correct shots can defeat it. Try to find a grey door which is carved a spade hole beside the corpse. After that, grab the green herb and go to the next door. Just go along the path.

## 4) WANDERING IN POLICE STATION

Go to the last door of the corridor. Kill four zombies. Then get to the save room (dark room) to save and prepare yourself if you want. Then go upstairs and solve the puzzle to take a Virgin Heart. Go to the next corridor. Fight three zombies here and go to the S.T.A.R.S. office. Grab the Unicorn Medal and Chris's diary. You can see a picture of S.T.A.R.S. and Chris's results. Open the locker to get the Grenade Launcher. Then get out. Find a locked door which is locked by Spade Key. Ignore it and return to the hall. Put the Medal on the platform of a white woman statue. You'll receive the Spade Key.

## 5) PLAYING CARDS ??? SPADE, DIAMOND, HEART &...

Go to the File room. Push the shelf until it's beside the cabinet and climb it, get the Crank. Then next to the door beside the S.T.A.R.S. office, use this key to open it and talk to Leon. There is another locked desk. Open it to get Flame rounds. Reach the library. Solve the puzzle to get Serpent Stone. Then get out by the big door. Kill the zombies. Run along the floor, put down the ladder and go to the next door (Waiting Room). You'll get the Lighter. Now you can return to the meeting room, solving the puzzle to take Virgin Heart.

Run to the next door of Waiting Room. One side of this corridor is being burnt. Go to the other side to the door there. You are in a dark corridor. Get ammo from the corpse and shoot the crows. Get to the end and open the door. You are on the terrace. Go downstairs to the courtyard. Fight four zombies and go to the next door. Grab the second Bow gun if you like and Valve Handle. There's another door here. I remind you not to open it you'll get trouble to yourself.

Return, go upstairs and get to the small path beside the helicopter and use the Valve Handle to open water putting out the fire.

Then get into the house and return to the place where half-helicopter was burning. Go to the Antique room and put the two Virgin Hearts on two ladies. You'll receive the half-Jaguar Stone from the knight statue. Take the Diamond Key on the mass beside and get out. Return to

the statue room and go downstairs. Use the Diamond Key to open the grey door, shoot zombies here. One of the lockers is Bowgun arrows and a film. Use Lockpick to get the Bomb. Go to the next door. Grab the green herb and find Marvin. Now he is turned into a dispirited zombie. Use Grenade Launcher to shoot him soon after he rises. Get the Detonator on the table, combine it with the Bomb and get out.

Go to the burning helicopter and use Bomb & Detonator and talk to Chief Irons. Find Sherry and grab the Heart Key on getting out. Return to the main hall.

Now go up the steps near the entrance and go to the room on the left. There is a crowd of zombies here. Shoot them. Don't go to the blue door soon. Get to the deeper door. You are in another corridor. Go to the first grey door by using the Diamond Key. Grab the Cord and Eagle Stone. A Licker will destroy the glass to haunt you. Just finish it. The interview room only has ammo. Okay, get out of this corridor and get to the big blue door. Kill zombies. Go to a small room and open the safe (the code is 2236) to get Acid rounds and map. Then go to the table to get two green herbs. Then run to the inside path. There are two doors. The door beside the corpse takes to the back yard with some green herbs. If you go upstairs, you'll find a door which is locked inside. Don't worry, it only takes you to the dark corridor you have already searched. So you choose the brown door which is locked by Heart Key. Open it. Put the Cord on the system which has the green light. Some shutters will cover the broken windows. This work is free that you can do or not. But later you'll understand why I remind you to do it. Go downstairs.

#### 6) BASEMENT

At the fork road, turn to Claire's left to a dirty area. Fight the dogs and climb down the ladder. Go to the save room and prepare yourself. When going out, you'll meet Sherry. She will pass the hole to bring you the Club Key. Now take control of Sherry and begin mission.

Try to avoid those annoying dogs. First, go to the room where Ada is to get ammo for Claire. Then go to the water room and solve the puzzle. Then pass the bridge and grab the key. Return and throw those things to Claire.

Take control of Claire. Go up the ladder and return to the corridor. Fight the zombies and get to Autopsy Room to get Red Card Key. Then go to Power Room to supply power and take the map. Use Red Card Key to open the Weapon storage. Grab ammo around and get things in the locker. After that, return to the police station.

Use Club Key to open the door you first see beside the stairs. Get ammo beside the corpse. Get out and return to the corridor where there is a green door. Open it with Club Key. You are in the TV room. Solve the puzzle and you'll get the G.Cogwheel from the picture. Get out and return to the library. Now go upstairs to the door that you didn't go. You are in the 3rd floor. Go to the next door, check the place, use Crank on the square hollow to make a new stairs. Go up on it and put the Cogwheel to the machine. A secret hole is opened. Grab the half-Jaguar Stone and create a complete one. Return to Irons's room to find Sherry and get down the elevator.

After hearing Irons's cry, go and talk to him. He was killed by William Birkin. Remember to bring your Machine Gun and climb down the ladder. Aim down your Machine Gun and kill the strange creature. Return and take Sherry with you. Pull down the ladder and go up.

#### 7) SEWER

After meeting Mr.X in a sight, Sherry will be dropped down by a drain. Take control the child. Go through the warehouse by the hole. Try to avoid the insects and get to the stains room. Grab the Wolf



Medal and...

Take control of Claire and continue the game. Go to your Control Room. Use Lockpick to open the warehouse, climb down it to get ammo if you want. Now get down the lift and head to the sewer path. Go north and check the corpse to get ammo. Then turn left (Claire's left) to another path. Go to the left door (talk to Annette) and use Valve Handle to pull down the bridge. After passing, pull it up and go to the alligator hall and fight the giant creature by the strategy as Leon's. Take Sherry and grab the Wolf Medal. Climb up the ladder, passing the bridge and take Eagle Medal. Get out of the area to the sewer path, put the two medals on the machine and run through the door in the waterfall. You'll meet Sherry here. Let's get on the train.

#### 8) FACTORY AREA

In the first corridor, kill four zombies, find the corpse to get Spark Shot if you want. Do the same in the 2nd corridor, then get up the ladder. Save here. Get on the train and try to find the Control Panel Room. Put it on the table to activate the train. Get on. Ready to fight 2nd William. Your best weapon is still Grenade Launcher with Flame Rounds. Try to heal your health frequently.

#### 9) LABORATORY AREA

After talking to Sherry, prepare yourself in this infirmary and get out.

Now go to the west to a fork road corridor. Get to the west area, turn left to the fusion room (full of fog). Grab the F.Aid Spray and Fuse Case. Use this thing with some machine in the right. It is changed into Main Fuse. Use this to put on the system I have said. The electric power is supplied. Now go to the east area. First, turn left to the last room (Researcher's room), get the Bow gun arrows and shoot the roots by Flame rounds, only one little shot. Then finish two Lickers in the next room. You'll get two boxes of Grenade Launcher in the locker. Then get out.

Now go to the left, put the switch to open the shutter. Finish the Plants. Go out, kill another plant and climb down the ladder. Go into the Licker corridor. Just take wipe of them all. Grab green herbs and go through the left path to Monitor Room. Save here if you want. Then go to William's experiment room, grab First Aid Spray and kill some Researcher zombies. Take the Lab Card Key and get out. Now you can go to the moth room by using this card and do as Leon A.

When you go out, Annette will be killed by her husband. Take the Vaccine cart from her. Then return to the west area, using Lab Card Key to open the first door. Grab the MO disc. Put the switch to lighten the room. Put Vaccine cart to a computer. Then go deeper and operate some machine on the wall. After that, return to the computer to get Base Vaccine. Reach William's experiment room again and put this thing into some machine in the corner of the room and get Vaccine.

Head to the Licker corridor, use the MO disc to open the shutter in the right. Go to it and prepare for your final battle.

#### 10) ESCAPE

Push the red button to operate the elevator. But you must face William again before getting out. Okay, four Magnum shots can wound him. After that, he has something wrong and changes into an unshape creature. Now it's really dangerous because he continually jump in the air everywhere. Just run around the room until he jumps to you and give you a big damage (heal your health soon). Then try to aim correctly and shoot him before he jumps away. Six or seven Magnum shots and defeat him.

Huff...Go down the elevator and get out of this hell. See a wonderful

FMV...

-----END OF CLAIRE SCENARIO A-----

=====

#### LEON SCENARIO B

=====

##### 1) COURTYARD

Now you are on the street. Just avoid those zombies and get to the gate. You're soon at Police Station courtyard. Go to the guard room to get Cabin Key and open the north door. Now you can't get here anymore because of the zombies. Get ammo. Then reach the next door. Fight the zombies and go upstairs. You'll see a FMV about the burning helicopter. As the first person, you must put out the fire.

##### 2) RPD POLICE STATION

Get to the dark corridor, grab the green herb and shoot the crows. If you are new to this game, go to the brown door first and go to Waiting room (save here) and grab the Small Key. Reach the main hall, get Unicorn Medal and put the button to pull down the ladder, descend. Grab the Shotgun on the table. Then return to the dark corridor.

Unlock the blue door, grab some green herbs and go downstairs to a room which is full of zombies. Get the Valve Handle, go to the small room and open the safe with the number 2236. You receive a map and Shotgun Shells. Return to the heliport and use the Valve Handle to put out the fire. Get another Shotgun Shells in the helicopter. Then go in to meet Mr.X

##### 3) MR.X

When you come in, you fight him soon. You can use Shotgun or Handgun to take him out. It's about six shots with Shotgun, twenty shots with Handgun. After that, return to the room where half-helicopter was burnt. Mr.X wakes up...

##### 4) WANDERING

Go to the Antique room to get the Blue Card Key . A Licker will jump down after you get it. Don't move. Shoot it by Shotgun. Get out and go to the main hall on 1st floor. Use the card to unlock all the electronic doors. Go up to 2nd floor and go to the library. Solve the puzzle here , you'll receive Bishop Plug . Then get to the next room. You'll see Sherry running to a hole. Chase after her and grab the Diamond Key, then talk to Claire. Then go to the S.T.A.R.S. office. Open the locker to get the Bow gun. Get "Chris's diary". Reach the north and go to the statue room. Solve the puzzle and get one Virgin Heart. Then go downstairs. Get to the save room to save if you want. Use Diamond Key to open the grey door (locker room). Then get to Marvin's place and take Heart Key. Then get out to the main hall. Put the Unicorn Medal on the woman statue to get Spade Key. Go to the left big door, shoot zombies here. Reach the next door until you are at the grey door of the File room, using Spade Key to open it. Get inside and take the First Aid Spray. Reach the next corridor to the meeting room. Use Lighter to get Virgin Heart.

Head to the Antique room, put the Virgin Hearts to the two ladies to get the King Plug.

Return to the main hall. Go up the steps near the front door and go to the left small door. Shoot zombies here. Don't go to the big blue door soon. Go to the deeper corridor, use Diamond Key to open the grey door and grab Rook Plug. Don't get the First Aid Spray or it will be a waste of time with the Licker. Then get out and go to the big blue door, use Heart Key to open the way to basement.

#### 5) BASEMENT

Leon continues to "invades" the parking lot. Meet Ada and help her to move the lorry. Then find Ben Bertolucci and grab the Manhole Opener. Go to the dog cage area and open the lid on the floor. Climb down, passing the Black Widows and go up. Go to the second room to put plugs. Then get out to meet Ada. Take control of Ada to grab the Club Key...

Kill those annoying zombies. First, go down the lift to get ammo for Leon. Then go to the water room and solve the puzzle. Pass the bridge and grab the key. Return and throw those things to Leon.

Take control of him. Go up the ladder and return to the corridor. Fight the zombies and get to Autopsy Room to get Red Card Key (There are Lickers here, not zombies). Then go to Power Room to supply power and take the map. Use Red Card Key to open the Weapon storage. Grab ammo around. The items in the locker depend on what Claire got. If you let Claire got all Machine Gun and Side Pack, now Claire would have nothing to get. After that, return to the police station.

#### 6) RETURN TO POLICE STATION

Use Club Key to open the door beside the stairs only to get Magnum rounds. Then take the key to open the TV room, solve the puzzle of the faucets. Mr.X comes again. Just do your best with your Shotgun. Take the G.Cogwheel and get out. Mr.X appears again in the corridor. Take him off and go to the 2nd floor to Chief Irons's area. At the room where Claire meets Sherry, grab the Crank in the box. Mr.X teases you again. Show him who you are. Then reach 3rd floor, use the Crank to make a new way and operate the system by G.Cogwheel to get Knight Plug and get down the hole.

Find and talk to Ben Bertolucci. Get the "Mail to Chief" and return to the room where you put plugs. You'll meet the first form of William Birkin. Keep a safe distance, using Magnum to shoot him. He is holding a bar and never let him beat you by it. You'll be shocked heavily and hard to continue the battle. Just four and five hits can make him weak and drop away. Put the last plugs and continue.

#### 7) SEWER

Go to your Control Room. Open the warehouse, climb down it to get ammo if you want. Now get down the lift to find Annette. Take control of Ada and play as Leon scenario A until Leon wakes up.

From here you can also reach Claire's control room in the other side. You need the Small Key to open her warehouse.

Okay, head to the sewer path. Go north and check the corpse to get Wolf Medal and Small Key to open the warehouse. Then turn left (Leon's left) to another path. Go to the left door and use Valve Handle to pull down the bridge. After passing, pull it up and go to the "alligator hall" (there's no alligator in scenario B) and take Ada with you. Climb up the ladder, passing the bridge and take Eagle Medal. Get out of the area to the sewer path, put the two medals on the machine and run through the door in the waterfall. Let's get on the train and "play" the old mini-game with William.

#### 8) FACTORY AREA

In the first corridor, kill four zombies, find the corpse to get Shotgun Part. Do the same in the 2nd corridor, then get up the ladder. Take control of Leon only. Prepare yourself here. Then get out. There's no train. Try to find a small lift and go down to the Control Panel

Room. Take the C.Panel Key and fight Mr.X.

In the save room, put the key on some machine on the right. Then go out, activate the train on the table and get on. Ready to enjoy the next play of William. This 3rd William continues to use sequences of hits to attack that make a lot of damage. So be careful.

#### 9) LABORATORY AREA

Leave Ada and go through the hole outside. You are dropped into inside of the elevator. Ada is being brought to the lower area.

Go into the Pump Room, use the big lift to get down. After getting down, get ammo beside the typewriter. Then use the small lift in the right to get down. Shoot the Lickers, then put the switch to supply power to the elevator. Now you can get out of here by using it. Kill the naked zombies and go to the right way to the main area. Go to the west area first, getting the Main Fuse to supply power. Then go to the east, grab ammo, Lab Card Key and Flamethrower from the Researcher's room and open the shutter in the left. Use Flamethrower to take off the Plants. Go out and descend the ladder. Go to Licker corridor, get green herbs and head to Monitor Room and pass it, too. Use Lab Card Key to open the moth room and enter the password "Guest" again if you like.

-----

#### ADDED NOTES :

With this work, you can return to the west area and enter the 2nd fingerprint to get into the Licker experiment room.

-----

Go to William's experiment room, get the Power Room Key and go out...

Return to the elevator and go down. In the Pump Room, push the box on the lift. Then get down with it. Remember to make necessary space to push. Move to the right, then to the north until it lies beside the others. Climb them and get to Power Room and see a FMV...

The warning about explosion appears. Take the Master key, use it to get into the infirmary to find Sherry. Then use it with the elevator to go down the railway to escape by train.

#### 10) ESCAPE

Go to the end of the train to save and get Platform Key. Get off and open the gate. Passing the steps to other pavement, put the machine to get Joint S Plug and Joint N Plug. Go to the next room and put them all in their place. After that, Mr.X appears again. This time, none of your weapons can take him off. Try to run, run like hell, sometimes shoot. Until 3 minutes are over, Ada appears to throw you the Rocket Launcher. Use it to play the finishing touch with this boss...

Okay, return to the train, shoot the naked zombies and operate the machine in the north to open the gate. Then get on. See a FMV...

After the incident, go to the back of the train. You'll fight the final sharp of William Birkin which is now an indefinite creature. This boss is not hard. Just try to shoot fast, as fast as you can that doesn't let it close you. Then get out and see the FMV ending...

-----END OF LEON SCENARIO B-----

-----

#### QUICK WALKTHROUGH

-----

\* USAGE : Anyone don't want your game to be spoiled easily. This walkthrough is the best to use.

- It doesn't show specific parts such as Save Room, location, items, weapons, ammunition etc. It doesn't show how to fight enemies. Its only property is the basic terms. Okay ?

-----  
SCENARIO A  
-----

1) STREET

- Go to the gun shop and talk to Kendo.
- Head to the end of the part until the zombies get out of the basket ball yard. Then continue to go.
- Get on the bus. Reach RPD Police Station.

2) RPD POLICE STATION

- Find Marvin to get Blue Card Key
- Unlock doors by accessing the computer. Then go to the east area.
- Fight a Licker, then continue.
- Find Virgin Hearts on the meeting room and 2nd floor.
- Grab Unicorn Medal in S.T.A.R.S. office. Put it on the statue at the hall to get Spade Key.
- Unlock all the Spade doors. Find Crank.
- In the library, solve the puzzle and grab Bishop Plug/Serpent Stone
- Get the Valve Handle from the back coutyard, then put out the fire
- Find Diamond Key and King Plug/half-Jaguar Stone
- Unlock the Diamond doors, one of them is Marvin's place.
- Read continue to know :

~~~~~  
LEON

CLAIRE

- |                                           |                                                                                        |
|-------------------------------------------|----------------------------------------------------------------------------------------|
| - Grab Heart Key from Marvin<br>Detonator | - Grab Bomb in Locker Room,<br>from Marvin and combine.                                |
| - Find Rook Plug and Cord.<br>bomb.       | - Explode the helicopter by the<br>bomb.                                               |
| - Enter the basement                      | Then go in to find Heart Key.<br>- Find Eagle Stone and Cord.<br>- Enter the basement. |

~~~~~  
3) BASEMENT

- Go to power room and try to supply power to the store.

~~~~~  
LEON

CLAIRE

- |                                                              |                           |
|--------------------------------------------------------------|---------------------------|
| - Goes to Parking Lot                                        | - Go to the right area    |
| - Talk to Ada and Ben                                        | - Take control of Sherry. |
| - Put the current Plugs to the<br>Door. Take control of Ada. | - Find Club Key and ammo. |
| - Find Club Key and ammo                                     |                           |

- ~~~~~
- Autopsy Room, find Red Card Key
  - Open the Weapon Storage and get items.
  - Return to Police Station.
  - In the TV Room, get G.Cogwheel.
  - In the library, go to the 3rd floor. Use Crank and Cogwheel to get Knight Plug/half-Jaguar Stone.
- ~~~~~

LEON

CLAIRE

- Jump to the basement.
- Fight G-Infant
- Put the last Plugs on the door
- Pick up Ada
- Return to Chief's place.
- Put the three stones on the picture
- Fight G-Infant
- Pick up Sherry

~~~~~

4) SEWER

- Get Valve Handle from Item Box.
- Find Wolf Medal.
- Fight Alligator.
- Grab Eagle Medal
- Put them on the machine in the right of sewer passage. Find the train and get on.

5) FACTORY

~~~~~

LEON

CLAIRE

- Fight William
- Get off
- Passing the corridors
- Find Control Panel Key and get on the train to Laboratory area.
- Fight William 2.
- Get off
- Passing the corridors
- Find Control Panel Key and get on the train to Laboratory area.
- Fight William 2

~~~~~

6) LABORATORY AREA

- Find Fuse Case and change it into Main Fuse
- Put on the center of area to supply power.
- Get ammo. Reach B5 area.
- Find Lab Card Key
- Grab Vaccine Cart from Annette (Claire only)
- Return to B4, grab MO disc with both characters. But Claire must make Vaccine Base.
- Leon escapes by using Mo disc soon. Claire makes Vaccine and escapes by using MO disc.

=====

-----

SCENARIO B

-----

1) STREET :

- Reach the back gate of Police Station

2) RPD POLICE STATION

- Grab Cabin Key and get in.
- Find Valve Handle, the put out the fire.
- Defeat Mr.X. Get Blue Card Key from Antique Room.
- Use it to open the Library. Go there and grab Bishop Plug/Serpent Stone. (Claire must get the Unicorn Medal on the wall, Leon needn't)

~~~~~

LEON

CLAIRE

- Chase after Sherry, grab  
get  
Diamond Key.
- Grab Virgin Heart.
- Use Diamond Key to find Heart  
Key and Rook Plug.

- Go to the S.T.A.R.S. office to  
Diamond Key.
- Grab Virgin Heart.
- Go get the Spade Key, open the  
File Room to take Lighter.
- Use Diamond key to find Bomb and  
Detonator. Then destroy and go to

the

Secret way behind the helicopter to  
Find Heart Key.

- Enter the basement.

- Enter the basement.

~~~~~

3) BASEMENT

- Activate the electric power in Power Room.

~~~~~

LEON

CLAIRE

- Goes to Parking Lot
- Talk to Ada and Ben
- Put the current Plugs to the  
door. Take control of Ada.
- Find Club Key and ammo

- Go to the right area
- Take control of Sherry.
- Find Club Key and ammo.

~~~~~

- Autopsy Room, find Red Card Key
- Open the Weapon Storage and get items.
- Return to Police Station.
- Leon gets Crank at Sherry's first place. Claire gets it at dog's cage  
area.
- In the TV Room, get G.Cogwheel. Fight Mr.X .
- In the library, go to the 3rd floor. Use Crank and Cogwheel to get  
Knight Plug/half-Jaguar Stone.

~~~~~

LEON

CLAIRE

- Jump to the basement.  
Mr.X.
- Fight William 1  
picture
- Put the last Plugs on the door
- Pick up Ada

- Return to Chief's place. Fight
- Put the three stones on the
- Fight William 1.
- Pick up Sherry

~~~~~

4) SEWER

- Get Valve Handle from Item Box. Try to control the bridge.
- Find Wolf Medal.
- Grab Eagle Medal
- Put them on the machine in the right of sewer passage. Find the train  
and get on.

5) FACTORY

~~~~~

LEON

CLAIRE

- Fight William
  - Get off
  - Passing the corridors
  - Find Control Panel by using a lift to monitor room.
  - Fight Mr.X.
  - Get on the train.
- Get off
  - Passing the corridors
  - Find Control Panel Key by using a lift to monitor room.
  - Fight Mr.X.
  - Get on the train.

~~~~~

6) LABORATORY AREA

- Find the switch to activate the elevator.
- Use it to go to B4 area.
- Find Fuse Case and change it into Main Fuse
- Put on the center of area to supply power.
- Get ammo. Reach B5 area.
- Find Lab Card Key and Power Room Key.
- Get down the elevator (Leon fights Mr.X here). Find Power Room and unlock.

~~~~~

LEON

CLAIRE

- Grab Master Key from Ada.
  - Go to the infirmary to save Sherry.
  - Use to Master to go to the railway railway.
- Get out of Power Room.
  - Find Sherry in B4 center and grab The Master Key.
  - Use Master Key to go to the

~~~~~

- Get the two Plugs to activate the train.
- Fight final Mr.X.
- Return to train, open the gate.
- Get on, fight William 5 and escape.

\*\*\*\*\*

09. F I L E S

\*\*\*\*\*

(\*Note : This file is for scenario A in Rookie Mode only. The data in the file is collected by playing the game.)

A. HINT FILES FOR ROOKIE MODE

A statue of a woman hearing a water vessel.

There's an inscription and a hole on the pedestal...

The statue holding a red jewel...



The two statues against each wall appear to have been moved before. Police staff have been told not move either unless necessary.

The water tank on the roof.

The tank ruptured on one occasion when the regulator valve handle was removed after the accident.

The door that has been destroyed by the helicopter.

The only way to open the sealed door is with explosives. There is a report that recently confiscated explosives have been stored on the premises.

A picture in the chief's room.

Word around the campfire is that there is a reason why the chief collects all these morose pictures other than as a hobby. He supposedly becomes furious if anyone touches them. He's even erupted at the cleaning staff.

A gas light in the press room.

The main fire must be lit before turning on the gas light. Turn them on in the correct order or they'll go out.

Clock Tower

The ladder must be lowered to gain access to the upper level. The clock has not been functioning since one of the gears was lost.

Sewage disposal plant door.

The lock device is supposedly shaped like a chess board because the manager loves chess obsessively.

A waterfall blocking the sewer.

The water flow must be locked to allow access to the other side of the waterfall. The small device on the wall off to the side is probably the key...

The ventilation fan and mobile bridge in the sewer.

Both devices are operated with the use of special handles that are usually detached.

The train turn table at the factory site.

The control panel for the turn table is set on the turn table itself. A custom key is required to activate it. Access is strictly prohibited.

Restoring the power to the lab.

The shutter can't be opened unless the breaker system has been restored.

The fuse consists of super conductive materials that can withstand high electrical output and must operate at extremely low temperature.

An insulated case is required during its transport.

Low temperature conditions must be maintained during their installation.

How to use the computer in the lab.

When typing the letter "A", move the cursor to "A" and then push the action button. When typing multiple letters, move the cursor over "\*" and then push the action button.

Elevator leading to the transport facility on the bottom floor.

The transport facility and the lab are connected by a large elevator lift located at the warehouse.

It can be reached from the passageway to the south of the control room [downward on the map]. A key is needed to open the shutter.

---

B. POLICE MEMORANDUM

This letter is just to inform everyone about the recent move of equipment that has happened during the precinct's rearrangements.

The safe with four digit lock has been moved from the S.T.A.R.S. office on the second floor, to the eastern office on the first floor.

2 2 3 6

Raccoon Police Liaison Dept

---

C. PATROL REPORT

September 20th 9:30pm

Reported : Sgt. Neil Carlsen

We received a report of a suspicious individual skulking around the sewer in the outskirts of Raccoon city. I searched the area and located the individual, but he ran away before I had a chance to question him.

I recover the following items :

- A small amount of C4 plastic explosives
- An electronic detonator
- 9x19 parabellium rounds
- Infrared scopel (broken)

End of report.

---

D. OPERATION REPORT 1

-Operation Report-

September 26th

The Raccoon Police Dept was unexpectedly attacked by zombies. Many have been injured. Even more were killed. During the attack, our communications we have decided to carry out an operation with the intent of rescuing any possible survivors as well as to prevent this disaster from spreading beyond Raccoon city. The details of the operation are as follows :

## Security of armaments and ammunition

Chief Irons has voiced concern regarding the issue of recent unresolved incidents. On the very day of the zombies' attack, he made the decision to relocate all weapons to scattered intervals throughout the building as a temporary measure to prevent their possible seizure. Unfortunately, this decision has made it extremely difficult for us to locate all ammunition caches. It has become our top priority to recover these scattered ammunitions.

To unlock the weapons storage.

As stated earlier, it will be extremely difficult to secure all ammunition. However, a considerable supply still remains in the underground weapon storage. Unfortunately, the person in charge of the key card used to access the weapon storage is missing and we have been unable to locate the key. One of the breaker's went down during the battle and the electronic locks are of functioning in certain areas. It has become a top priority to restore the power in the power room and secure those locks.

Recorder : David Ford

September 27th

1:00pm. The west barricade has been broken through and another exchange ensued. We sheltered the injured in the confiscation room on the first floor temporarily. Twelve more people were injured in the battle.

Reporter : David Ford

### -Additional Report-

Three additional people were killed following the sudden appearance of an as yet unknown creature. This creature is identified by missing patches of skin and razor-like claws. However, its most distinguishing characteristic is its lance-like tongue capable of piercing a human torso in an instant. Their numbers as well as their location remaining unknown. We have tentatively named this creature the "Licker" and are currently in the process of developing countermeasure to deal with this new threat.

---

## E. OPERATION REPORT 2

### -Operation Report-

September 28th

Early Morning 2:30am. Zombies overran the operation room and another battle broke out. We lost four more people, including David.

We're down to four people, including myself. We failed to secure the weapons cache and hope for our survival continue to diminish. We won't last much longer...We agreed upon a plan to escape through the sewer. There's a path leading from the precinct underground to the sewage disposal plant. We should be able to access the sewers through there. The only drawback is that there is no guarantee the sewage disposal plant is free of any possible danger.

We know our chances in the sewers are slim, but anything is better than simply waiting here to die.

In order to buy more time, we locked the only door leading to the underground, which is located in the eastern office. We left the key behind in the eastern office since it's unlikely that any of those

creatures have the intelligence to find it and unlock the door.

I pray that this operation report will be helpful to whoever may find it.

Recorder : Elliot Edward

-----  
F. CHRIS'S DIARY

August 8th

I talked to the chief today once again, but he refused to listen to me. I know for certain that Umbrella conducted T-virus research in that mansion. Anyone infected turns into a zombie. But the entire mansion went up in the explosion; along with any incriminating evidence. Since Umbrella employs so many people in town, no one is willing to talk about the incident. It looks like I'm running out of options.

August 17th

We've been receiving a lot of local reports about the strange creatures appearing at random throughout the city. This must be the work of Umbrella.

August 24th

With the help of Jill and Barry, I finally obtained information vital to this case. Umbrella has begun research on the new G-virus, a variation of the original T-virus. Haven't they done enough damage already? We talked it over, and have decided to fly to the main Umbrella HQ in Europe. I won't tell my sister about this trip because doing so will put her in danger.

Please forgive me Claire.

-----  
(\*Note : This file is for Claire only)

G. MAIL TO CHRIS

Mr. Chris Redfield  
Raccoon City Police Dept  
S.T.A.R.S. division

As per your request, we have conducted our internal investigation and discovered the following information :

1) Regarding the G-virus currently under development by Umbrella Inc.

So far it is unconfirmed that the G-virus even exists. We're continuing with our investigation.

2) Regarding Mr. Brian Irons, Chief of the Raccoon Police Dept.

Mr. Irons has allegedly received a large sum of funds in bribes from Umbrella Inc. over the last five years. He has apparently involved in the cover up of the mansion case along with several other incidents in which Umbrella appears to have direct involvement. Mr. Irons had been arrested under psychiatric evaluation as a result of the charges but released due to circumstantial evidence as well as his phenomenal academic standing.

As such extreme cautions advised when dealt with him.

Jack Hamilton  
Section Chief

Internal Investigation  
United States Federal  
Police Department

---

H. CHIEF'S DIARY

September 23rd

It's all over. Those imbeciles from Umbrella have finally done it...Despite all their promises, they've ruined my town. Soon the streets will be infested with zombies. I'm beginning to think that I may be infected myself. I'll kill everyone in town if this turns out to be true !!!

September 24th

I was successful in spreading confusion among the police as planned. I've made sure that no one from the outside will come to help. With the delays in police station, no one will have the chance to escape my city alive. I've seen to it personally that all escape routes from inside the precinct have been cut off as well. There are several survivors still attempting to escape through the lower levels, but I'll make sure no one gets out.

September 26th

I've had a change of heart about the remaining survivors inside the precinct. I've decided to hunt them down myself. I shot Ed in the back through the heart less than an hour ago. I watched him writhe in pain upon the floor in a pool of his own blood. The expression on his face was positively exquisite. He died with his eyes wide open, staring up at me. It was beautiful. I wonder if the mayor's daughter is still alive? I let her escape so I could enjoy hunting her down later...I'm going to enjoy my new trophy. Yes, frozen forever in the pose I choose to give her.

---

I. INVESTIGATE REPORT ON P-EPSILON GAS

This report demands immediately attention.

The P-Epsilon gas has been proven capable of incapacitating all known B.O.W.s. As such, it has been designated for emergency usage in the event of a B.O.W. escape. Report based on data collected during the prior incidents indicate the potential for negative side effects.

The P-Epsilon has proven to weaken the B.O.W.s cellular functions. However, prolonged exposures will result in the creation of adaptive antibodies to the agent. Furthermore some species have been observed to absorb the P-Epsilon gas as a source of nutrition and use the toxins extracted against anything that is a threat.

Use of P-Epsilon gas should be severely limited to extreme cases only. We strongly request the authority to re-evaluate the P-Epsilon gas development system. We would like this re-evaluation take place immediately.

2nd R&D Room/Security Team

---

J. SECRETARY'S DIARY A

April 6th

I accidentally moved one of the stone statues on the second floor when I leaned against it. When the chief found out about it, he was furious. I swear the guy nearly bit my head off, screaming at me never to touch the statue again. If it's that important, maybe they shouldn't have put it out in the open like that...

April 7th

I heard that all the art pieces from the chief's collection are rare items, literally worth hundreds of thousand of dollars. I don't know which is the bigger mystery : where he finds these tacky things, or where he's getting the money to pay for them.

May 10th

I wasn't surprised to see the chief come in today with yet another large picture frame in his hands. This time it was a really disturbing painting depicting a nude person being hanged. I was appalled by the expression on the chief's face as he leered at that painting. Why anyone would consider something like that to be a work of art is beyond my comprehension...

---

K. SECRETARY'S DIARY B

June 8th

As I was straightening up the chief's room, he burst through the door with a furious look on his face. It's only been 2 months since I've started working here, but that was the second time I've seen him like this. The last time was when I bumped into that statue, only this time he looked even more agitated than ever. I serious thought for a moment that he was going to hurt me.

June 15th

I finally discovered that the chief has been hiding all along...If he finds out that I know, my life will be in serious danger. It's getting late already. I'm just going to have to take this a day at a time...

---

L. MAIL TO CHIEF

To : Mr. Brian Irons, Chief of the Raccoon City Police Dept

We have lost the mansion lab facility due to the renegade operative, Albert Wesker. Fortunately, his interference will no lasting effect upon our continued virus research. Our only present concern is the presence of the remaining S.T.A.R.S. members : Redfield, Valentine, Burton, Champer and Vickers. It comes to light that S.T.A.R.S. have any evidence to the activities of our research, dispose of them in a way that would like purely accidental. Continue to monitor their progress and make certain their knowledge does not go public. Annette will continue to be your contact throughout this affair.

William Birkin

To : Mr. Brian Irons, Chief of the Raccoon City Police Dept

I have deposited the amount of \$10000 to the account for your

services this term as per agreement. The development of the G-virus scheduled to replace the T-virus, is near completion. Once completed, I am certain that I will be appointed to be a member of the Executive board for Umbrella Inc. It is imperative that we proceed with caution. Redfield and the remaining S.T.A.R.S. members are still attempting to uncover information on the project. Continue to monitor their activities and block all attempts to investigate the underground research facilities.

William Birkin

To : Mr. Brian Irons, Chief of the Raccoon City Police Dept

We have a problem. I have received information informing me that Umbrella HQ has sent spies to recover my research on the G-virus. There are a number of unknown agents involved. They must not be allowed to take this project away from me as it represents my entire life work. Search the city thoroughly for any suspicious persons. Detain any such individuals by whatever means possible and contact me immediately through Annette. With these precautions, any possible threat should be eliminated. I will not allow anyone to steal my work on the G-virus. Not even Umbrella...

William Birkin

---

M. WATCHMAN'S DIARY

August 11th

I finally had the chance to see blue skies for the first time in ages, but did a little to lift my spirit. I was reprimanded by the chief for neglecting my duties while I was up on the clock tower. There's only one thing I still don't understand : the chief seemed more concerned about the fact that I was up on the tower rather than that I was neglecting my duties. Why was access to the tower prohibited in the first place anyway ?

September 5th

I recently talked to the old man who works in the scrap yard out back. His name is Thomas. He's a quiet man and really seems to enjoy chess. He even went so far as to design a special key and lock engraved with chess pieces on them for one of the doors in the disposal yard. We made plans to play chess tomorrow night. I can't help but wonder how good he is. One thing that's been bothering me about him is the way that he's always scratching himself...Does he have some sort of skin disease or is he rude ?

September 9th

Thomas is a much better player than I has imagined. I used to think of myself as a fairly decent player, but he did a pretty good job of humbling me. About the only thing I imagine that could match his skills in chess is his appetite. All the guy did was talk about food throughout the entire game. He sounded fairly healthy, but he didn't look quiet right...I wonder if he's okay.

September 12th

I was supposed to play another game of chess with Thomas, but we had to cancel because he hasn't been feeling too well. He stopped by to see me, but I told him to go back and rest since he literally looked like the walking dead. He insisted he was just fine, but I could tell he was really having problems. Come to think of it, I haven't been feeling too

good myself lately...

---

N. SEWER MANAGER FAX

User List of the Connecting Facility

On the first and third Wednesday of the month, Angelica Margaret, chief of maintenance, will make use of the facilities. Be sure to reduce the moisture levels in the facility by activating the fan, as the equipment she will be using is susceptible to the effects of water vapours. On the 28th of every month, the chemical transporter Don Weller will use the facility. The chemicals he will be transporting are extremely volatile. Extreme caution should be observed throughout their transport. On the 6th and 16th of every month, police chief Brian Irons will visit the facility to attend the regular meeting that take place in the lab. On the 4th Friday of every other month, William Birkin will use the facility to conduct a training seminar for the Chicago branch of Umbrella Inc. as the probability of an attack upon William Birkin will be high, take every measure conceivable to guard his life. You will be informed of all other potential visitors and times they will arrive as needed. Guide these individuals to their destination safely. We expect nothing but the best for you.

Charles Coleman  
Secretary Chief  
Umbrella Headquarters

---

O. SEWER MANAGER'S DIARY

June 28th

It's been a while, but I saw Don today and we talked after completing our work. He told me he had been sick in bed until yesterday.

It really doesn't come as much of a surprise given how long he's been working here.

He was sweating like a horse and kept scratching his body while we were talking. I asked if he was hot, but he just looked at me funny. What's wrong with him anyway ?

July 7th

Chief Irons has been visiting the lab quite often lately. I don't know what he's doing over there but he always looks grim. The expression on his face has been even more unsettling than usual...

My guess is that it's because of Dr. Birkin's impossible requests. The chief has my sympathies though. After all he's done for the town, he doesn't deserve this.

July 21st

I rarely drink because I'm on the graveyard shift, but I don't suppose I have much to complain about it since this is how I make my living.

August 16th

Chief Irons came in late today, looking grimmer than his usual self. I tried to joke with him to cheer him up but he wasn't amused. He pulled his gun and threatened to shoot me ! I was able to calm him down, but that guy must have some serious problems. He knows he can't



enter the lab without my help and my medal. This is what it means for the chief "to serve and protect" !?

August 21st

William informed me that the police and media have begun their investigation on Umbrella's affair. He said that the investigation will be citywide and that there is a possibility they'll even search through the sewer. He asked me to suspend all Umbrella sewer facility operations until the investigation has concluded. The sewer will still be used for passage, but he stressed that I have to be extremely cautious and that I'd lose my job if anyone finds out about this operation.

---

#### P. LABORATORY SECURITY MANUAL

-Security measure in case of an emergency-

In the instance of an uncontrollable biohazardous breakout, all security measures will be directed toward the underground transport facility.

In the instance that any abnormalities are detected among cargo in transit, designated high-speed train. At which point, all materials will be isolated and disposed of without delay.

In the instance of a Class 1 emergency, the entire train will be purged and disposed of without delay.

In the instance that the lab itself becomes contaminated, the northernmost route currently used to transport materials to and from the facility will be designated as an emergency escape route. This route will secure passage to the relay point outside the city limits.

Disclosure about any information regarding research conducted here, or the existence of this facility, is strictly prohibited.

Since it is top priority to keep all research classified, escape access may be denied under certain extenuating circumstances.

---

#### Q. USER REGISTRATION

Temporary User Registration for the Culture Experiment Room.

User Name : "GUEST"

Password : None

Valid for 24 hours.

---

(\*Note : This file is in Claire A only)

#### R. INSTRUCTION FOR SYNTHESIS OF THE G-VIRUS ANTIGEN : G-VACCINE CODE NAMED "DEVIL."

Any beings infected by the G-virus will reproduce through the impregnation of an embryo within another living being.

Unless rejected by the host, the embryo will undertake a process of gradual cellular invasion, infecting the host's cells on a molecular level as it rewrites their DNA.

Once the metamorphosis is complete, the host will be capable of continuing this cycle of self-replication. The duration of time for the process to run its course will vary from subject to subject. In the early stages of cellular invasion, it is possible to halt progression of the metamorphosis through the administration of the G-vaccine

antigen.

The following procedure details its synthesis.

The vaccine creation requires the base vaccine. This can be arranged by the activator VAM. First set the empty cartridge to the VAM and activate it. After the several moments the process will be complete and the white-color base vaccine will be set in the cartridge automatically. Then confirm the green light is on, remove the cartridge and proceed to the next step. Once the base vaccine has been prepared, set it in the vaccine synthesis machine located in the P-4 level experiment room. The machine is fully automated and only requires the user to push the sequence start switch. At this point, the program will run automatically and synthesis will be complete within approximately 10 seconds.

As the synthesis of DEVIL is an extremely delicate process, the quality will vary with slight shocks or changes in temperature. Careful handling is required for the proper results.

-----

S. FILM A

Code G Human Body Experiment  
9/15 15:24

-----

T. FILM B

Picture in front of the Arukas tailor.  
Regressed into a zombie within two hours.

Subject repeatedly complained about severe agitation of the epidermis in addition to feelings of nausea.

This happened up to the moment he lost consciousness.

Picture by R.Lambert

-----

U. FILM C

Development Code: T-103

Due to accelerated metabolism relative to the earlier 00 series, this subject possesses exemplary regenerative capabilities.

PH-X016 File Data

-----

V. FILM D

Recruit

-----

-----

=====

FILE LOCATION

=====

- A. HINT FILES FOR ROOKIE MODE
  - Standard file of Rookie Mode, scenario A.
- B. POLICE MEMORANDUM
  - the east room in the main hall
- C. PATROL REPORT
  - File Room
- D. OPERATION REPORT 1
  - Meeting Room
- E. OPERATION REPORT 2
  - Dark Room
- F. CHRIS'S DIARY
  - S.T.A.R.S. office
- G. MAIL TO CHRIS
  - S.T.A.R.S. office (Claire only)
- H. CHIEF'S DIARY
  - Chief's room (beside the helicopter)
- I. INVESTIGATE REPORT ON P-EPLISON GAS
  - Pump Room (scenario B only)
- J. SECRETARY'S DIARY A
  - Waiting Room
- K. SECRETARY'S DIARY B
  - Sherry's place
- L. MAIL TO CHIEF
  - on the secret area to sewer (Claire)
  - from Ben (Leon)
- M. WATCHMAN'S DIARY
  - Watchman's room
- N. SEWER MANAGER FAX
  - Control Room
- O. SEWER MANAGER'S DIARY
  - beside the sewer manager's corpse
- P. LABORATORY SECURITY MANUAL
  - in the laboratory
- Q. USER REGISTRATION
  - in the laboratory
- R. INSTRUCTION FOR SYNTHESIS OF THE G-VIRUS ANTIGEN  
G-VACCINE. CODE NAMED "DEVIL"
  - from Annette (Claire A only)
- S. FILM A
  - Locker Room (scenario A only)
- T. FILM B

- TV Room (scenario A)
- Locker Room (scenario B)

U. FILM C

- Prison (scenario B only)

V. FILM D (secret file)

- S.T.A.R.S. Office

-----  
-----

-----  
FILE EXPLANATION  
-----

- A. This file is for Leon only. It guides the rookie cop about the puzzles in the Police Station.
- B. This file tells you the number to open the safe in eastern office.
- C,D and E files mainly tell you about the past and current events of the Raccoon City or RPD Police Station.
- F. Chris tells you about his investigation to the Umbrella Inc. He had gone to Europe without telling Claire-his sister because he doesn't want her to be in danger.
- G. An answer letter to Chris about the Umbrella investigation he had demanded.
- H. Iron's diary. The incident about the G-virus in the city made him insane and kill everyone there.
- I. A report a P-Eplison gas.
- J and K files are diary of a secretary telling us about the current events, too.
- L. A mail from Researcher William Birkin to Chief Iron. He needs his help and insists that no one could steal the G-virus from him, even the Umbrella.
- M. Watchman's Diary tells about the current events.
- N. Tells us about the waterfall which blocks the way to the train. Using the two medals.
- O. The current events in sewer.
- P. This files give us some hints about the escape train of the Laboratory area when necessary.
- Q. The username of the system computer in Moth Room.
- R. Tell us how to make the G-Vaccine.

\*\*\*\*\*

10/ M.A.P.S.

\*\*\*\*\*

- \* Explanation :
- V,<,> : Doors
- HHH : stairs, ladder
- E : elevator, lift
- S : Save point (typewriter)
- B : Item Box
- O : Hole

-----  
POLICE STATION 1F  
-----

```

!!-- V ---!!   ! HHH !
!! 7      !!__!10__H!
!!      !__< !   !_____! 13 < !   !!V--!!
!6!   !   8   !! 9 !   !_____!!   !!   !!
!V-   !_V_____<_!_S_B!   ! 14   !! 15   !!18 !!
! !__!   >   !_____< !   !!   !!
! ! 4 !   5   _____!   S   !   !_>_____!!----!!
! ! ! !   !   !   !   _____!V_17!
! < !_!_____!   2   >   1   ! !   ! !
!__3_____>_____B!   !!1!   12   ! !
           !   HHH   ! <   ! !HHH
           !__ V _____<_!_____<16_!

```

- Area 1 : Main Hall
  - + Ink Ribbons
  - + Handgun Bullets (scenario A)
  - + Shotgun (Leon B)
  - + Grenade Launcher (Claire B)
  
- Area 2 :
  - + Police Memorandum (File)
  - + First Aid Spray (scenario A)
  - + Handgun Bullets (scenario B)
  
- Area 3 : Licker Corridor
  - + Handgun Bullets
  - + Green Herb
  
- Area 4 : File Room
  - + Patrol Report (File)
  - + Crank (scenario A)
  - + First Aid Spray (Leon B)
  - + Lighter (Claire B)
  - + Ink Ribbons
  
- Area 5 : Marvin's place
  - + Handgun Bullets
  - + Small Key (Leon B)
  - + Heart Key (Leon)
  - + Green Herb
  - + Detonator (Claire)
  
- Area 6 : N/A
  
- Area 7 : Meeting Room
  - + Operation Report (File)
  - + Handgun Bullets (Leon)
  - + Virgin Heart
  
- Area 8 : Locker Room
  - + Shotgun Shells (Leon)
  - + Bow gun arrows (Claire)
  - + Bomb (Claire)
  - + Film
  
- Area 9 : Dark Room
  - + Clothes
  - + Colt S.A.A. (Claire)

- + Operation Report 2 (File)
- + Ink Ribbons
  
- Area 10 :
  - + 2 Green Herbs
  
- Area 11 :
  - + Green Herb
  - + Red Herb
  
- Area 12 : west office
  - + Valve Handle (scenario B)
  - + Handgun Bullets
  - + Shotgun Shells (Leon)
  - + Acid Rounds (Claire)
  - + Map
  
- Area 13 : Interview Room
  - + First Aid Spray (scenario B)
  - + Cord (scenario A)
  - + Rook Plug (Leon)
  - + Eagle Stone (Claire)
  
- Area 14 :
  - + Handgun Bullets
  
- Area 15 : TV room
  - + Film
  - + G.Cogwheel
  
- Area 16 :
  - + 2 Green Herbs
  
- Area 17 :
  - + 2 Green Herbs
  - + Shotgun Shells (Leon)
  
- Area 18 : Watchman's Room
  - + Watchman's diary
  - + Shotgun Shells (Leon)
  - + Magnum (Leon A)
  - + Magnum Rounds (Leon B)
  - + Acid Rounds (Claire)

-----  
 POLICE STATION 2F  
 -----

```

                                     _____
                                     ! 12 !
                                     !____!
!HHH ! _____ ! _____ H
! H! _____ 1 _____ ! !-----!_! H
! H! ! -- H-- ! ! ! 13 < ! 11 H
! _____ ! ! ! ! ! _____ V! ! _!
! 5 ! ! ! ! ! ! ! 14 _____ !V! _ >
! > _____ ! ! 2 < ! ! ! ! ! ! ! ! -- -!!
! ! _____ ! ! ! ! ! ! ! 15 ! ! ---V! _____ !!
! > 4 ! ! _____ V _____ ! ! ! ! ! > _____ !7! ! ! ----!
! ! _____ ! _____ ! ! ! ! B < ! 8 ! ! _
! ! _____ ! 3 ! ! ! ! ! < 6 S! ! _____ ! ! HHHH
! _____ > _____ ! ! ! ! ! _____ ! < 9 _____ < !10 H

```

ITEMS :

- Area 1 : 2nd Hall
  - + Unicorn Medal (scenario B)
  
- Area 2 : Library
  - + Red Herb
  - + Bishop Plug (Leon)
  - + Serpent Stone (Claire)
  
- Area 3 :
  - + VK70 part (Leon)
  - + Flame Rounds (Claire)
  - + Handgun Bullets
  - + Shotgun Shells (Leon B)
  - + Diamond Key (Leon B)
  
- Area 4 : S.T.A.R.S. office
  - + Chris' diary
  - + Mail to Chris
  - + Diamond Key (Claire B)
  - + Unicorn Medal (scenario A)
  - + Shotgun (Leon A)
  - + Magnum (Leon B)
  - + Grenade Launcher (Claire A)
  - + Bow Gun (Claire B)
  - + First Aid Spray (Leon)
  - + Handgun Bullets
  - + Film
  
- Area 5 : Statue Room
  - + Handgun Bullets
  - + Virgin Heart
  
- Area 6 : Waiting Room
  - + Secretary's diary A
  - + Ink Ribbons
  - + Lighter (Claire A)
  - + Small Key (Leon A)
  
- Area 7 : N/A
  
- Area 8 : Antique Room
  - + Diamond Key (scenario A)
  - + Blue Card Key (scenario B)
  - + King Plug (Leon)
  - + Half Jaguar Stone (Claire)
  - + Shotgun Shells (Leon)
  - + Ink Ribbons
  
- Area 9 : Dark corridor
  - + Green Herb (scenario B)
  - + Handgun Bullets
  
- Area 10 :
  - + Green Herb
  
- Area 11 : Heliport
  - + Handgun Bullets (scenario A)





```

! O ! ! _____ !_V!_V_!1!_____!!
_____!_V ! ! _____V_____!
!V_____! 9 ! ! ! ! _____!
! !----! ! ! ! ! ! ! ! 3 !
!8 _____! ! !_____! 6 !_! ! ! !
! > _____! !_7_____< <_____! !_____!
!_!_____! ! ! ! !
! ! ! !
!_____!

```

ITEMS :

- Area 1 : N/A
- Area 2 : Power Room
  - + Green Herb
  - + Map
- Area 3 : Autopsy Room
  - + Red Card Key
- Area 4 :
  - + Red Herb
- Area 5 : Weapon Storage
  - + Machine Gun
  - + Side Pack
  - + Shotgun Shells (Leon A)
  - + Handgun Bullets
  - + Acid Rounds (Claire)
  - + Magnum Rounds (Leon B)
- Area 6 : Parking Lot
  - + Green Herb
- Area 7 :
  - + Handgun Bullets (Leon A / Claire B)
  - + Film (Leon B)
- Area 8 : Prison
  - + Green Herb
  - + Blue Herb
  - + Mail to Chief (Leon)
  - + Manhole Opener (Leon)
  - + Bow gun arrows
- Area 9 : Dogs' cages
  - + Red Herb
  - + Blue Herb

-----  
 SEWAGE DISPOSAL MAP  
 -----

```

! _____! ! 4 !
! _____V! ! !
!V_____!_!_____V!
!_ _____! ! !
! ! ! ! _____! !
!_!3!_! _____!

```

```
      !V_____!!      !!_____
!  _!_6_<_!_____!_____E !
!---! !                          !5!
!S 1> !                          ! !_____
!B--! !      _____< !      !_!_____ !
      ! !      !_____!      !SB! !
      !H      !_____!      !2_> !
      !H      ! !      ! !
_____!!      ! !      ! !
!!-----!      ! !      !H!
!!      ! !
!!      ! !
!!      !_!
!!
!!---H
!----H
```

ITEMS :

- Area 1 :
  - + Blue Herb
  - + Ink Ribbons
- Area 2 :
  - + Ink Ribbons
- Area 3 :
  - + G-Infant (monster)
- Area 4 : Water Room
  - + Club Key
  - + Map
- Area 5 :
  - + Shotgun Shells (Leon)
- Area 6 :
  - + Grenade Rounds (Claire)

-----  
SEWER MAP B1  
-----

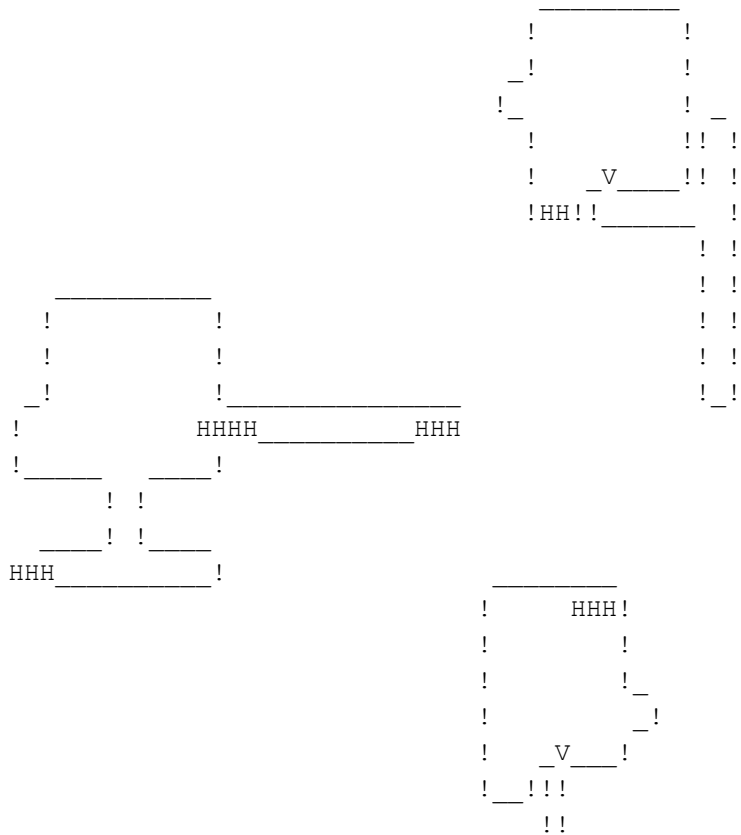

!! \_\_\_\_\_  
! \_\_\_\_\_<

- ITEMS :
- Leon :
    - + Ink Ribbons
    - + First Aid Spray
    - + Eagle Medal
    - + 3 Green Herbs (B)
    - + Sewer Manager's diary
    - + Sewer Manager Fax
  - Claire :
    - + Ink Ribbons
    - + First Aid Spray
    - + Eagle Medal
    - + 3 Green Herbs (B)
    - + Sewer Manager's diary
    - + Sewer Manager Fax

-----  
SEWER MAP B2  
-----

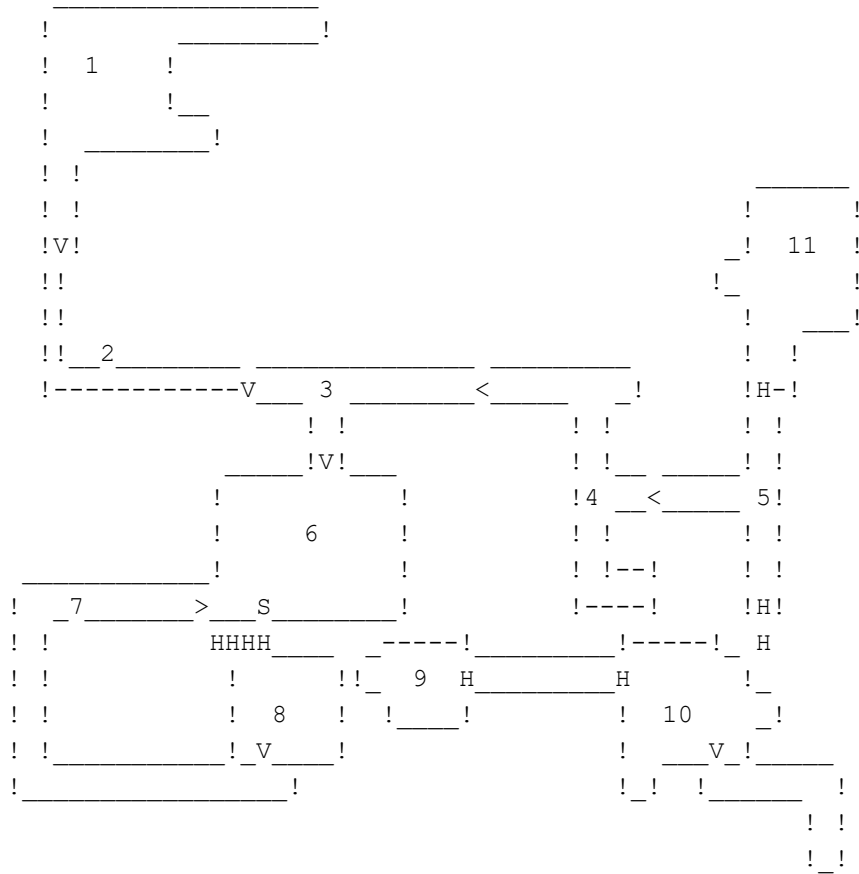

- ITEMS :
- Area 1 : N/A
  - Area 2 : N/A
  - Area 3 : N/A
  - Area 4 :
    - + Shotgun Shells (Leon A)
    - + Wolf Medal (Leon & Claire B)
    - + Small Key (Leon B)
    - + Flame Rounds (Claire)
  - Area 5 :
    - + Map

- Area 6 : Bridge Room
  - + Blue Herb (infinite)
  - + Shotgun Shells (Leon)
  - + Flame Rounds (Claire)
  - + 2 Green Herbs
  - + Ink Ribbons
  - + Map
- Area 7 :
  - + Alligator (monster)
- Area 8 :
  - + Wolf Medal (Claire A)
- Area 9 :
  - + Wolf Medal (Sherry)
- Area 10 :
  - + Grenade Rounds (Claire)
  - + Acid Rounds (Claire)
  - + Shotgun Shells (Leon B)
  - + Magnum Rounds (Leon B)
- Area 11 :
  - + Shotgun Shells (Leon)
  - + Magnum Rounds (Leon)
  - + Grenade Rounds (Claire B)
  - + Flame Rounds (Claire B)

-----  
 VACANT FACTORY B1  
 -----

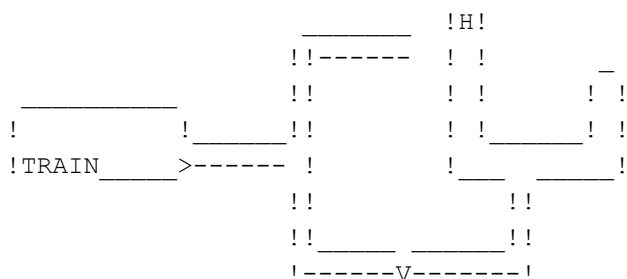

ITEMS :

- Leon :
  - + Green Herbs (A)
  - + Shotgun Part
  - + Blue Herb (B)
- Claire :
  - + Green Herbs (A)
  - + Spark Shot
  - + Blue Herbs (B)

-----  
 VACANT FACTORY 1F (SCENARIO A)  
 -----

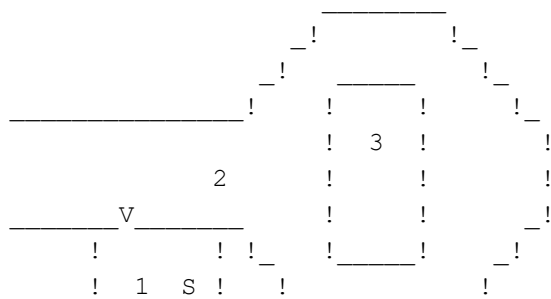

!\_\_\_\_\_B!      !\_\_\_\_\_!

ITEMS :

- Area 1 :
  - + Magnum Rounds (Leon)
  - + Shotgun Shells (Leon)
  - + Flame Rounds (Claire)
  - + Acid Rounds (Claire)
- Area 2 :
  - + Map
  - + Handgun Bullets
- Area 3 :
  - + Control Panel Key
  - + Magnum Rounds (Leon)
  - + Flame Rounds (Claire)

-----  
 VACANT FACTORY 1F (SCENARIO B)  
 -----

(This map is available before the train comes.)

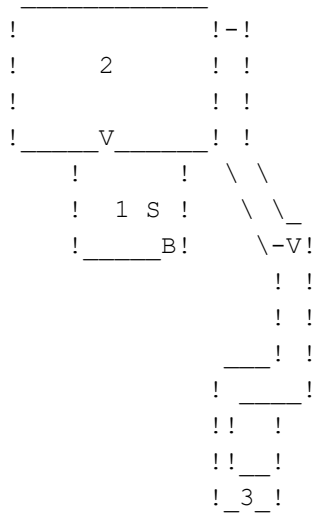

- Area 1 :
  - + Magnum Rounds (Leon)
  - + Shotgun Shells (Leon)
  - + Flame Rounds (Claire)
  - + Acod Rounds (Claire)
- Area 2 :
  - + Map
  - + Handgun Bullets
- Area 3 :
  - + Control Panel Key

-----  
 LABORATORY B1  
 -----

This map is available in scenario B only.

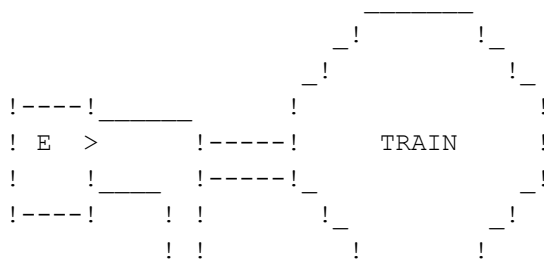

```

!!
!!
!!
!!
!!
!V! _____ !! ! 2!
!   ! !__ <_!   ! !
!  1  ! ! ! ! ! !
!  _ _!  !_!   ! !
!   !E! _____ !_! _____!
!   !   !   !
!   !   !   !
!_B_! _____!

```

- ITEMS :
- Area 1 :
    - + Green Herb
  - Area 2 :
    - + Master Key (Leon)

-----  
 LABORATORY B2  
 -----

This map is available in scenario B only.

```

_____
!         !!         !
!         !!         !
!         !!         !
!  _____!!_----!--!
!  !E         _____!_E!
!  !         !         !
!  !         !         !
!  !         _____!
!  !         _____S!
!--!-----!

```

- ITEMS :
- + Shotgun Shells (Leon)
  - + Acid Rounds (Claire)

-----  
 LABORATORY B3  
 -----

```

_____
!         !         !
!         !         !
!         !         !
!         !         !
!_ _ !         !
!!         !         !
!!_ _!         !
!_____!_____!

```

ITEMS : N/A

-----

LABORATORY B4

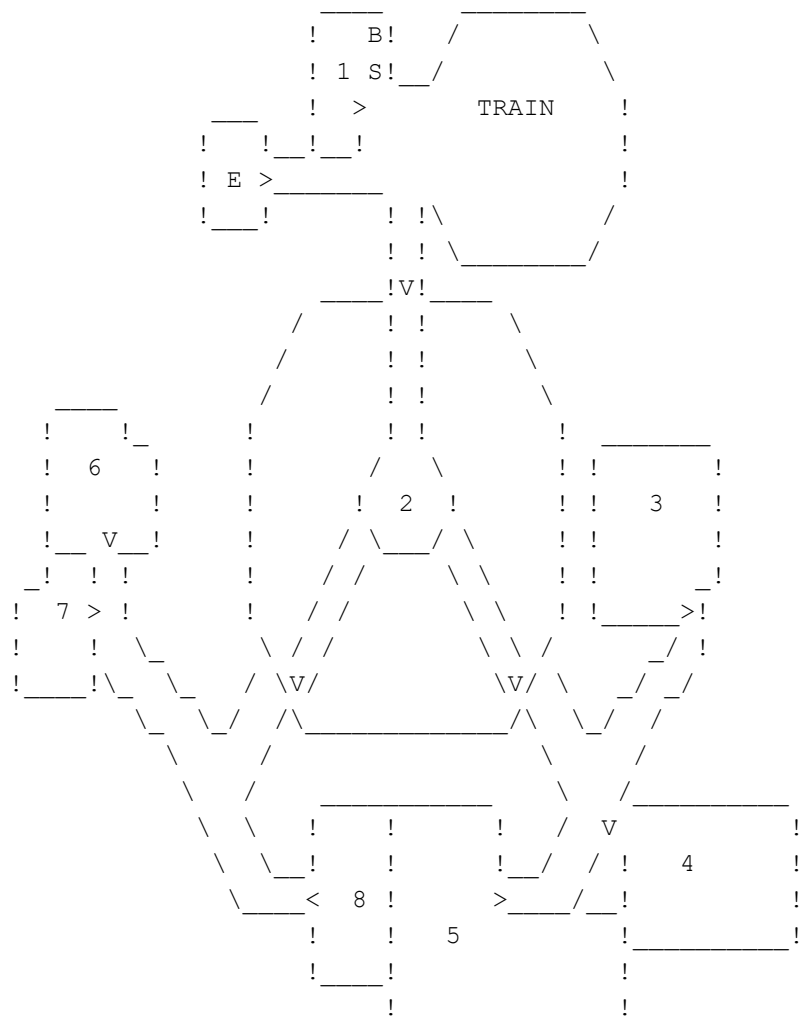

ITEMS :

- Area 1 : Infirmary
  - + Green Herb
  - + Magnum Rounds (Leon)
  - + Acid Rounds (Claire)
  - + Flame Rounds (Claire)
- Area 2 : N/A
- Area 3 : Fusion Room
  - + First Aid Spray
  - + Fuse Case
- Area 4 :
  - + Shotgun Shells (Leon)
  - + Grenade Rounds (Claire)
  - + MO disc (scenario A)
  - + Vaccine Cart (Claire A)
- Area 5 : Licker Experiment
  - + Machine Gun
- Area 6 : Computer Room
  - + Flamethrower (Leon)
  - + Bow Gun arrows (Claire)
  - + Laboratory Security Manual
  - + User Registration
  - + Lab Card Key (scenario B)

+ Blue Herb

- Area 7 :

+ Shotgun Shells (Leon)

+ Grenade Rounds (Claire)

- Area 8 :

+ 2 Green Herbs

-----  
LABORATORY B5  
-----

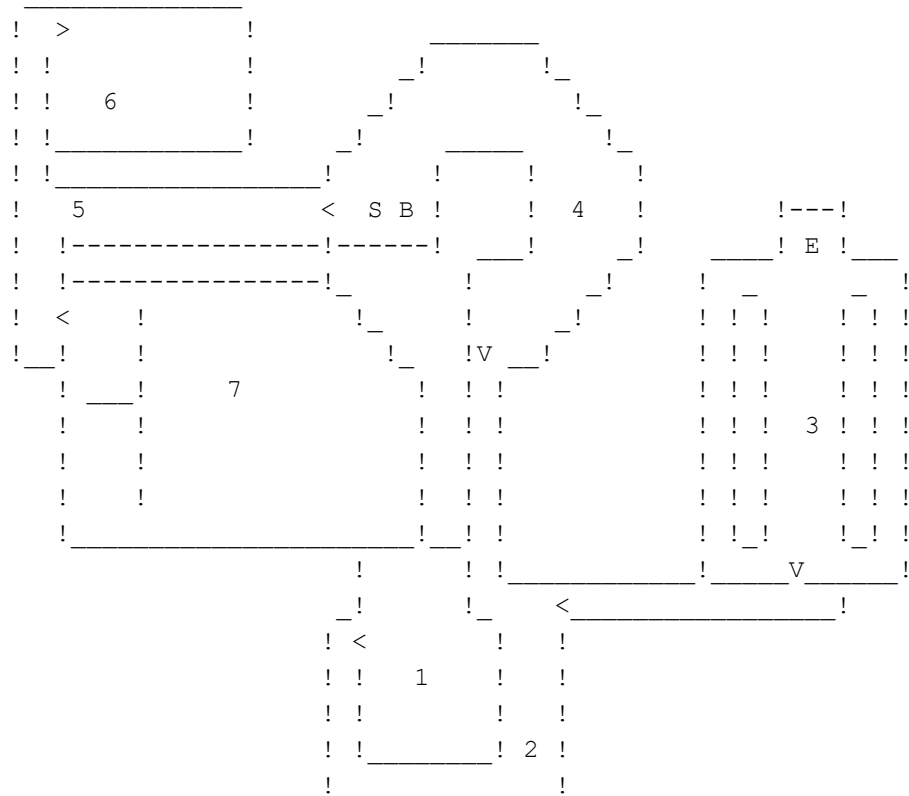

ITEMS :

- Area 1 : N/A

- Area 2 : Licker corridor

+ 4 Green Herbs

- Area 3 :

+ William 4 (monster)

- Area 4 : Monitor Room

+ Map

+ Ink Ribbons

- Area 5 :

+ Red Herb

- Area 6 : Moth Room

+ Huge Moth (monster)

- Area 7 : William's Experiment Room

+ First Aid Spray

+ Lab Card Key (scenario A)

+ Power Room Key (scenario B)



=====

-----

MAP LOCATION

-----

| MAPS                          | LOCATION               |
|-------------------------------|------------------------|
| - Police Station Map          | - Eastern office       |
| - Police Station Basement Map | - Power Room, basement |
| - Sewage disposal Map         | - Water Room           |
| - Sewer B1 Map                | - Annette corridor     |
| - Sewer B2 Map                | - Bridge Room          |
| - Factory Map                 | - Train area           |
| - Laboratory Map              | - Monitor Room         |

\*\*\*\*\*

11. I T E M L I S T

\*\*\*\*\*

Okay, if you don't want to view the confusing maps to find items,  
just see this board.

-----\

ITEM LIST \

-----\

| NAME            | LOCATION                                                                      |
|-----------------|-------------------------------------------------------------------------------|
| - Locker Key    | - From Brad Vickers, RPD station                                              |
| - Cabin Key     | - Guard Room                                                                  |
| - Lighter       | - Waiting Room (Claire A)<br>- File room (Claire B)                           |
| - Blue Card Key | - From Marvin, RPD station                                                    |
| - Red Card Key  | - Autopsy Room                                                                |
| - Virgin Hearts | - Meeting Room<br>- Statue Room                                               |
| - Unicorn Medal | - S.T.A.R.S. office (A)<br>- 2nd floor main hall (B)                          |
| - Spade Key     | - Main Hall                                                                   |
| - Diamond Key   | - Antique Room (A)<br>- From Sherry (Leon B)<br>- S.T.A.R.S office (Claire B) |
| - Heart Key     | - Marvin's place (Leon)<br>- Chief Irons's place (Claire)                     |
| - Club Key      | - Water Room, basement                                                        |
| - King Plug     | - Antique Room                                                                |
| - Rook Plug     | - The Interview Room                                                          |

|                     |                                                                            |
|---------------------|----------------------------------------------------------------------------|
| - Bishop Plug       | - Library                                                                  |
| - Knight Plug       | - Police Station 3F                                                        |
| - Serpent Stone     | - Library                                                                  |
| - Eagle Stone       | - Interview Room                                                           |
| - Jaguar Stone      | - half in Antique Room<br>- half in Police Station 3F                      |
| - Valve Handle      | - Heliport                                                                 |
| - Bomb              | - Locker Room                                                              |
| - Detonator         | - Marvin's place                                                           |
| - Manhole Opener    | - Dog cage area, basement                                                  |
| - Crank             | - File room (A)<br>- Decorated Room (Leon B)<br>- Dog cage area (Claire B) |
| - G. Cogwheel       | - TV Room                                                                  |
| - Wolf Medal        | - Sewer path (Leon and Claire B)<br>- Alligator hall (Claire A)            |
| - Eagle Medal       | - Upper sewer                                                              |
| - Control Panel Key | - Train (A)<br>- Secret Monitor Room (B)                                   |
| - Main Fuse         | - Fusion Room, Laboratory                                                  |
| - Lab Card Key      | - William's experiment room (A)<br>- Researcher's room (B)                 |
| - Vaccine Cartridge | - From Annette                                                             |
| - Base Vaccine      | - Vaccine Room                                                             |
| - Vaccine           | - William's experiment room                                                |
| - MO Disc           | - Machine Room                                                             |
| - Power Room Key    | - William's experiment room                                                |
| - Master Key        | - Power Room (Leon B)<br>- Laboratory center (Claire B)                    |
| - Platform Key      | - Train                                                                    |
| - Joint S Plug      | - Railway                                                                  |
| - Joint N Plug      | - Railway                                                                  |

\*You can see more specific by seeing "Maps" menu.

| ITEMS              | FUNCTION                                                                                              |
|--------------------|-------------------------------------------------------------------------------------------------------|
| - Locker Key       | - open the locker in Dark Room                                                                        |
| - Cabin Key        | - open the back door to police station courtyard.                                                     |
| - Lighter          | - burning the picture to get Virgin Heart<br>- solving the G.Cogwheel puzzle                          |
| - Blue Card Key    | - open the main doors in the main hall                                                                |
| - Red Card Key     | - open the Weapon Storage                                                                             |
| - Virgin Hearts    | - getting the King Plug (Leon)<br>- getting half-Jaguar Stone (Claire)                                |
| - Unicorn Medal    | - getting the Spade Key                                                                               |
| - Spade Key        | - unlock the doors carved spade hole                                                                  |
| - Diamond Key      | - unlock the doors carved diamond hole                                                                |
| - Heart Key        | - unlock the door carved heart hole                                                                   |
| - Club Key         | - unlock the doors carved club hole                                                                   |
| - King Plug        | - open the door to sewer                                                                              |
| - Rook Plug        | - open the door to sewer                                                                              |
| - Bishop Plug      | - open the door to sewer                                                                              |
| - Knight Plug      | - open the door to sewer                                                                              |
| - Serpent Stone    | - open a secret way underground                                                                       |
| - Jaguar Stone     | - open a secret way underground                                                                       |
| - Eagle Stone      | - open a secret way underground                                                                       |
| - Valve Handle     | - controlling the water putting out the fire burning the helicopter<br>- controlling the sewer bridge |
| - Bomb             | - combine with Detonator                                                                              |
| - Detonator        | - combine with Bomb                                                                                   |
| - Detonator & Bomb | - making explosion to open a new way after the spoiled helicopter                                     |
| - Manhole Opener   | - open a lid in basement area                                                                         |
| - Crank            | - creating new way on 3rd floor                                                                       |

|                     |  |                                        |
|---------------------|--|----------------------------------------|
| - G. Cogwheel       |  | - activating the clock on 3rd floor    |
| ~~~~~               |  | ~~~~~                                  |
| - Wolf Medal        |  | - stopping the waterfall in sewer      |
| ~~~~~               |  | ~~~~~                                  |
| - Eagle Medal       |  | - stopping the waterfall in sewer      |
| ~~~~~               |  | ~~~~~                                  |
| - Control Panel Key |  | - activating the train to lab area     |
| ~~~~~               |  | ~~~~~                                  |
| - Main Fuse         |  | - supplying electric power to area     |
| ~~~~~               |  | ~~~~~                                  |
| - Lab Card Key      |  | - open the Machine Room (Vaccine room) |
| ~~~~~               |  | - open the moth room                   |
| ~~~~~               |  | ~~~~~                                  |
| - Vaccine Cartridge |  | - used to create Base Vaccine          |
| ~~~~~               |  | ~~~~~                                  |
| - Base Vaccine      |  | - used to create Vaccine               |
| ~~~~~               |  | ~~~~~                                  |
| - Vaccine           |  | - cure Sherry of G-virus               |
| ~~~~~               |  | ~~~~~                                  |
| - MO Disc           |  | - open a shutter in Lab area           |
| ~~~~~               |  | ~~~~~                                  |
| - Power Room Key    |  | - unlock Power Room                    |
| ~~~~~               |  | ~~~~~                                  |
| - Master Key        |  | - unlock the infirmary (Leon B only)   |
| ~~~~~               |  | - control the elevator to railway      |
| ~~~~~               |  | ~~~~~                                  |
| - Platform Key      |  | - unlock a door to railway area        |
| ~~~~~               |  | ~~~~~                                  |
| - Joint S Plug      |  | - supplying power to Train             |
| ~~~~~               |  | ~~~~~                                  |
| - Joint N Plug      |  | - supplying power to Train             |
| ~~~~~               |  | ~~~~~                                  |

\*\*\*\*\*

## 12. WEAPON LIST

\*\*\*\*\*

\* USAGE :

- "Weapon List" lists the names and locations of weapons.
- "Weapon Function" shows you characteristics of each weapons :
  - + Range : the attack distance
  - + Correct ratio : the percentage of correct shots
  - + Capacity : How much ammo the weapons bring each time reloading
  - + Advantage : Weapon's good points
  - + Weakness : Weapon's bad points

-----

=====

### WEAPON LIST

=====

|                |  |                          |
|----------------|--|--------------------------|
| ~~~~~          |  | ~~~~~                    |
| - Combat knife |  | - Standard weapon        |
| ~~~~~          |  | ~~~~~                    |
| - VP70 Handgun |  | - Leon's standard weapon |
| ~~~~~          |  | ~~~~~                    |

|                       |  |                                    |
|-----------------------|--|------------------------------------|
| - VP70 part           |  | - RPD Police Station 2F            |
| ~~~~~                 |  | ~~~~~                              |
| - Browning HP Handgun |  | - Claire and Ada's standard weapon |
| ~~~~~                 |  | ~~~~~                              |
| - Beretta M92F        |  | - Chris's standard weapon          |
| ~~~~~                 |  | ~~~~~                              |
| - Shotgun             |  | - From Robert Kendo                |
|                       |  | - RPD Police Station               |
| ~~~~~                 |  | ~~~~~                              |
| - Shotgun part        |  | - Factory area                     |
| ~~~~~                 |  | ~~~~~                              |
| - Spark Shot          |  | - Factory area                     |
| ~~~~~                 |  | ~~~~~                              |
| - Flamethrower        |  | - Researcher's Room, Laboratory    |
| ~~~~~                 |  | ~~~~~                              |
| - Magnum              |  | - RPD Police Station 1F            |
| ~~~~~                 |  | ~~~~~                              |
| - Magnum Part         |  | - Laboratory B5                    |
| ~~~~~                 |  | ~~~~~                              |
| - Bow gun             |  | - From Robert Kendo                |
|                       |  | - RPD Police Station               |
| ~~~~~                 |  | ~~~~~                              |
| - Grenade Launcher    |  | - RPD Police Station               |
| ~~~~~                 |  | ~~~~~                              |
| - Colt S.A.A pistol   |  | - In the Locker, Dark Room         |
| ~~~~~                 |  | ~~~~~                              |
| - Machine Gun         |  | - Weapon Storage (Original game)   |
|                       |  | - standard item (Arrange game)     |
|                       |  | - Get A or B rank in scenario B    |
|                       |  | under 3 hours (Original game)      |
| ~~~~~                 |  | ~~~~~                              |
| - Gatling Gun         |  | - Standard item in arrange game    |
|                       |  | - Get A or B rank in scenario B    |
|                       |  | under 2:30 hours (Original game)   |
| ~~~~~                 |  | ~~~~~                              |
| - Rocket Launcher     |  | - Final battle of scenario B       |
|                       |  | - Get A or B rank in scenario A    |
|                       |  | under 2:30 hours                   |
|                       |  | - standard item (Arrange game)     |
| ~~~~~                 |  | ~~~~~                              |

=====

WEAPON FUNCTION

=====

A. COMBAT KNIFE

~~~~~

Range : Very short  
Correct ratio : 8/10  
Capacity : N/A  
Advantage : powerful strength  
Weakness : short range

B. VK70 HANDGUN

~~~~~

Range : long  
Correct ratio : 8/10  
Capacity : 18 bullets

Advantage : mediocre power, high speed, long range, effective with most popular enemies.

Weakness : not strong enough to fight powerful enemies.

#### ENHANCED VK70 HANDGUN

Range : long

Correct ratio : 8/10

Capacity : 18 bullets

Advantage : mediocre power, automatic guns, long range, effective with most popular enemies.

Weakness : not strong enough to fight powerful enemies.

#### C. BROWNING HP

~~~~~

Range : long

Correct ratio : 8/10

Capacity : 13 bullets

Advantage : mediocre power, high speed, long range, effective with most popular enemies.

Weakness : not strong enough to fight powerful enemies.

#### D. BERETTA M92F

~~~~~

Range : long

Correct Ratio : 8/10

Capacity : 15 bullets

Advantage : mediocre power, high speed, long range, sometimes bursting the enemy's head in high correct ratio, effective with most enemies.

Weakness : Not strong enough to fight powerful enemies.

#### E. SHOTGUN

~~~~~

Range : long and large

Correct ratio : 9/10

Capacity : 5 shells

Advantage : strong power, wonderful range, effective with most enemies and bosses.

Weakness : slow speed, small capacity.

#### ENHANCED SHOTGUN

Range : long and larger than the ordinary one

Correct ratio : 9/10

Capacity : 7 shells

Advantage : strong power, wonderful range, effective with most enemies and bosses.

Weakness : slow speed, small capacity.

#### F. SPARK SHOT :

~~~~~

Range : long

Correct ratio : 10/10

Capacity : 100%

Advantage : mediocre power, effective with some strong enemies

Weakness : take 2 blanks in inventory, very slow speed, not effective with popular enemies.

G. FLAMETHROWER

~~~~~

Range : short

Correct ratio : 6/10

Capacity : 100%

Advantage : indefinite power, effective with humanoid plants.

Weakness : take 2 blanks in inventory, not effective with popular enemies.

H. MAGNUM

~~~~~

Range : long

Correct ratio : 8/10

Capacity : 8 rounds

Advantage : very strong power, can be shot through any enemies on the way and kill them at once. Effective with any enemies. The Magnum can be enhanced by using its part (available for Leon only).

Weakness : Almost none

I. BOW GUN

~~~~~

Range : very long

Correct ratio : 7/10

Capacity : 18 arrows

Advantage : shoot three arrows at the same time, mediocre power, effective with big enemies.

Weakness : not effective with creepy enemies (dogs, Lickers, etc)

Special abilities : shoot 3 arrows one time

J. GRENADE LAUNCHER :

~~~~~

Range : short and large

Correct ratio : 9/10

Capacity : 1 round (reload each time shooting)

Advantage : used with various rounds : Grenade, Acid and Flames. Very strong power, effective with any enemies, can cast one shot on a group of enemies. Each rounds is effective to definite enemies. See "Monster List" for more details.

Weakness : short range, slow speed (reload each time shooting)

K. COLT S.A.A

~~~~~

Range : long

Correct ratio : 8/10

Capacity : 6 bullets

Advantage : high speed, effective with most popular enemies, mediocre power.

Weakness : small capacity, not strong enough to fight strong enemies.

L. MACHINE GUN

~~~~~

Range : long

Correct ratio : 10/10

Capacity : 100%

Advantage : shoot continuously, high speed, strong power, effective with most popular enemies.

Weakness : Almost none.

M. GATLING GUN

~~~~~

Range : long and large  
Correct ratio : 10/10  
Capacity : N/A

Advantage : shoot continuously a group of enemies, strong power, effective with most popular enemies.

Weakness : heavy and slow, can't be aimed up or down.

N. ROCKET LAUNCHER

~~~~~

Range : long  
Correct ratio : 9/10  
Capacity : N/A

Advantage : one shot can kill any enemies. Very strong power, effective with strong enemies.

Weakness : heavy and slow, can't be aimed up or down (not effective with creepy enemies).

\*\*\*\*\*

13. M O N S T E R L I S T

\*\*\*\*\*

\* USAGE :

- "Characteristics" introduces about the remarkable points of each enemy. You can find how they look, what their attacks are and how to realize them in this part.
- "Strategy" shows you the general basics to attack and defend when fighting the each type enemies.
- "Weak against" shows you what kind of ammo the enemies are afraid of.
- "Ammo to kill" shows you how much ammo you take to kill each type.

-----  
ZOMBIES  
-----

- Characteristics : Your most popular enemies. They are a bit slow. Attack by biting your neck or blowing poisonous breath. Sometimes on moving, they suddenly fall under your feet to bite. When moving they make sounds at their feet. What a deceive ! When falling on the ground, sometimes they only pretend to die that eats your foot if you pass. There are some types of this monster :

- + Ordinary zombies
- + Female zombies
- + Police Officer zombies
- + Naked zombies

- Strategy : Keep a safe distance and shoot until it falls. Then see if it dies or not.

- Weak against : fire and explosion

- Ammo to kill :

- Handgun Bullets : 4-10 bullets
- Shotgun Shells : 1-3 shells
- Bow Gun Arrows : 3-9 arrows (1-3 shots)
- Magnum Rounds : 1 round
- Grenade Rounds : 1-2 rounds
- Acid Rounds : 1-2 rounds



Flame Rounds : 1-2 rounds  
Rocket Launcher : 1 shot  
Machine Gun : 3-7%

-----  
ZOMBIE DOGS  
-----

- Characteristics : Your second most popular enemies. They're very fast which attack by their wild nature : scratching or biting.
- Strategy : let the dogs in your aim. Then shoot each time they run forward you in the right way.
- Weak against : fire and explosion.
- Ammo to kill :
  - Handgun Bullets : 5-10 bullets
  - Shotgun Shells : 1-3 shells
  - Bow Gun Arrows : 6-15 arrows
  - Magnum Rounds : 1-2 rounds
  - Grenade Rounds : 1-2 rounds
  - Acid Rounds : 1-2 rounds
  - Flame Rounds : 1-2 rounds
  - Rocket Launcher : 1 shot
  - Machine Gun : 3-7%

-----  
LICKERS & SUPER LICKERS  
-----

- Characteristics : new enemies in Resident Evil 2 transformed from human. Lickers are red, super Lickers are a bit green and tougher. They have no eyes and very sensitive with sounds. They are rather slow. But when furious, they become violent and fast. Attack by scratching feet or using tongue to strike that make a lot of damage. But when they are in fury, they can jump and slice your head with a bigger damage. When moving they make sounds at their feet and their breath.
- Strategy : When you know there are Lickers in the area, never do you run. Your sounds will make them furious and attack heavily. Use large-range weapons as Shotgun or Grenade Launcher to shoot with a safe distance. Remember, don't move.
- Weak against : Acid
- Ammo to kill :
  - Handgun Bullets : 15-20 rounds
  - Shotgun Shells : 2-4 rounds
  - Bow Gun Arrows : 15-21 arrows
  - Magnum Rounds : 2-4 rounds
  - Grenade Rounds : 2-3 rounds
  - Acid Rounds : 1-2 rounds
  - Flame Rounds : 2-5 rounds
  - Rocket Launcher : 1 shot
  - Machine Gun : 6-10%

-----  
BLACK WIDOWS  
-----

- Characteristics : popular enemies. They are some kind of spiders which attack by dropping poisonous liquid from the ceiling or using legs to strike. They often live in wet places.
- Strategy : Running is the best. But you can also kill it by aim up your weapons.

- Weak against : fire
- Ammo to kill :
  - Handgun Bullets : 10-20 bullets
  - Shotgun Shells : 2-5 shells
  - Bow Gun Arrows : 9-18 arrows
  - Magnum Rounds : 1-2 rounds
  - Grenade Rounds : 1-3 rounds
  - Acid Rounds : 1-3 rounds
  - Flame Rounds : 1-3 rounds
  - Rocket Launcher : N/A
  - Machine Gun : 3-10%

-----  
SMALL SPIDERS  
-----

- Characteristics : They were born from the dead mother Black Widows. Attack by jumping which lose a very small damage.
- Strategy : Shooting these is a waste of ammo because they are very crowded. Just run and try to step them.
- Weak against : every ammo
- Ammo to kill :
  - Handgun Bullets : 1-5 bullets
  - Shotgun Shells : 1-2 shell
  - Bow Gun Arrows : 3-6 arrows
  - Magnum Rounds : 1-5 rounds
  - Grenade Rounds : 1 round
  - Acid Rounds : 1 round
  - Flame Rounds : 1 round
  - Rocket Launcher : N/A
  - Machine Gun : 1-3%

-----  
CROWS  
-----

- Characteristics : flying monsters live in multiple. Attack suddenly by scratching your head in the air.
- Strategy : Use handgun and aim following their ways. Just be calm.
- Weak against : every ammo
- Ammo to kill :
  - Handgun Bullets : 1 bullet
  - Shotgun Shells : 1 shell
  - Bow Gun Arrows : 3 arrows
  - Magnum Rounds : 1 round
  - Grenade Rounds : 1 round
  - Acid Rounds : 1 round
  - Flame Rounds : 1 round
  - Rocket Launcher : 1 shot
  - Machine Gun : 1-3%

-----  
HUMANOID PLANTS & SUPER HUMANOID PLANTS  
-----

- Characteristics : G-virus plants. The ordinary is green. But the super is a bit red. Attack by striking, throwing poisonous air or eating your head. They are very slow. When moving they make sounds at their roots.

- Strategy : Use Fire elemental weapons to defeat it. If not you can use explosion weapons. Never let it "hug" you because there two unlucky fates waiting for you : You would be poisoned continuously or it would eat your head.

- Weak against : Fire

- Ammo to kill :

Handgun Bullets : 15-25 bullets

Shotgun Shells : 3-5 shells

Bow Gun Arrows : 12-21 arrows

Magnum Rounds : 3-7 rounds

Grenade Rounds : 3-5 rounds

Acid Rounds : 3-5 rounds

Flame Rounds : 2-3 rounds

Rocket Launcher : 1 shot

Machine Gun : 10-20%

Flamethrower : 3-5%

-----  
G-INFANT  
-----

- Characteristics : It was born from William's body part. Slow and a bit stupid. I don't know if it has a name, but Resident Evil fans call it with a lot of manes : G-Imago, G-baby etc. It attacks by striking or coughing out parasite scorpions.

- Strategy : Machine Gun or any weapons shooting continually. Aim down and shoot that doesn't let the scorpions climb your body.

- Weak against : N/A

- Ammo to kill :

Handgun Bullets : N/A

Shotgun Shells : N/A

Bow Gun Arrows : N/A

Magnum Rounds : N/A

Grenade Rounds : N/A

Acid Rounds : N/A

Flame Rounds : N/A

Rocket Launcher : N/A

Machine Gun : 50-70%

-----  
PARASITE SCORPIONS  
-----

- Characteristics : born from G-Infant. Attack by draining blood.

- Weak against : N/A

- Strategy : use continuous-shot weapons and aim down.

- Ammo to kill :

Handgun Bullets : 1-5 bullets

Shotgun Shells : 1 shell

Bow Gun Arrows : 3-6 arrows

Magnum Rounds : 1 round

Grenade Rounds : 1 round

Acid Rounds : 1 round

Flame Rounds : 1 round

Rocket Launcher : N/A

Machine Gun : 1-2%

-----  
COCKROACHES  
-----

- Characteristics : They live in wet and hidden places such as the hole

passage on the wall or the pipes in dump area.

- Weak against : N/A
- Strategy : Running is the best way.
- Ammo to kill :
  - Handgun Bullets : 1-2 bullets
  - Shotgun Shells : 1 shell
  - Bow gun Arrows : 3-6 arrows
  - Magnum Rounds : 1 round
  - Grenade Rounds : 1 round
  - Acid Rounds : 1 round
  - Flame Rounds : 1 round
  - Rocket Launcher : N/A
  - Machine Gun : 1-2%

-----  
SMALL WORMS  
-----

- Characteristics : Small worms living in wet and disused place. They just crawl on the floor, attacking by some fluid.
- Weak against : N/A
- Strategy : Just use a large-ranged weapon if you want to kill them. But it's better for you to run.
- Ammo to kill :
  - Handgun Bullets : 1-2 bullets
  - Shotgun Shells : 1 shell
  - Bow gun Arrows : 3-6 arrows
  - Magnum Rounds : 1 round
  - Grenade Rounds : 1 round
  - Acid Rounds : 1 round
  - Flame Rounds : 1 round
  - Rocket Launcher : N/A
  - Machine Gun : 1-2%

-----  
CATERPILLAR  
-----

- Characteristics : some kind of butterfly that lives in the secret lab. They mainly attack by throwing some fluid.
- Weak against : heat
- Strategy : Just strike it by any strong weapons before it could touch you with the liquid.
- Ammo to kill :
  - Handgun Bullets : 15-25 bullets
  - Shotgun Shells : 2-5 shell
  - Bow gun Arrows : 9-18 arrows
  - Magnum Rounds : 2-5 round
  - Grenade Rounds : 2-5 round
  - Acid Rounds : 2-5 round
  - Flame Rounds : 2-5 round
  - Rocket Launcher : N/A
  - Machine Gun : about 20%

-----  
MR.X 1  
-----

- Characteristics : another type of Tyrant. Cold, huge and...slow.

## Attack

by punching and striking.

- Strategy : Shoot continually by powerful weapons.

- Weak against : explosion

- Ammo to kill (each battle)

Handgun Bullets : 15-25 bullets

Shotgun Shells : 5-10 shots

Bow Gun Arrows : 15-30 arrows

Magnum Rounds : 5-10 rounds

Grenade Rounds : 5-10 rounds

Acid Rounds : 5-10 rounds

Flame Rounds : 5-10 rounds

Rocket Launcher : 1-2 shots

Machine Gun : 4-10%

## ----- MR.X 2

- Characteristics : has more claws and very fast. No ordinary ammo can defeat him. Attack by sequences of claw strikes.

- Strategy : Run, run like hell. Run until you get the Rocket Launcher from Ada. Then aim him correctly to play the finishing blow.

- Weak against : explosion

- Ammo to kill :

Handgun Bullets : infinite

Shotgun Shells : infinite

Bow Gun Arrows : infinite

Magnum Rounds : infinite

Grenade Rounds : infinite

Acid Rounds : infinite

Flame Rounds : infinite

Rocket Launcher : 1 shot

Machine Gun : infinite

## ----- WILLIAM 1

- Characteristics : Doesn't change so much : half-human, half-monster. He is not very powerful now. Attack by striking.

- Strategy : use powerful weapons to shoot and keep a safe distance. Just don't let it strike you. You'll be shocked very much.

- Weak against : N/A

- Ammo to kill :

Handgun Bullets : 15-30 bullets

Shotgun Shells : 10-15 shells

Bow Gun Arrows : 15-30 arrows

Magnum Rounds : 10-15 rounds

Grenade Rounds : 10-15 rounds

Acid Rounds : 10-15 rounds

Flame Rounds : 10-15 rounds

Rocket Launcher : 1-2 shot

Machine Gun : 15-30%

## ----- WILLIAM 2

- Characteristics : changes more than the 1st form and begins to have

sharp claws. Big and slow. Attack very fast by striking claws.

- Strategy : use powerful weapons and frequently check your health and heal.

- Weak against : N/A

- Ammo to kill :

Handgun Bullets : very much

Shotgun Shells : 10-20 shells

Bow Gun Arrows : very much

Magnum Rounds : 10-20 rounds

Grenade Rounds : 10-20 rounds

Acid Rounds : 10-20 rounds

Flame Rounds : 10-20 rounds

Rocket Launcher : 1-3 shot

Machine Gun : very much

-----  
WILLIAM 3  
-----

- Characteristics : has more claws and hands. Now can't realize as a human. He's a real monster. Attack by doing a sequence of hits.

- Strategy : the same as William 2.

- Weak against : N/A

- Ammo to kill :

Handgun Bullets : very much

Shotgun Shells : 10-20 shells

Bow Gun Arrows : very much

Magnum Rounds : 10-20 rounds

Grenade Rounds : 10-20 rounds

Acid Rounds : 10-20 rounds

Flame Rounds : 10-20 rounds

Rocket Launcher : 1-3 shots

Machine Gun : very much

-----  
WILLIAM 4  
-----

- Characteristics : a four leg monster which has a lot of deadly thorns on his chest. It usually jumps in the air to confuse the enemies and corner them to kill by his thorns.

- Strategy : Use powerful weapons. Run around until he lands and then shoot correctly and continually.

- Weak against : N/A

- Ammo to kill :

Handgun Bullets : very much

Shotgun Shells : 10-20 shells

Bow Gun Arrows : very much

Magnum Rounds : 10-20 rounds

Grenade Rounds : 10-20 rounds

Acid Rounds : 10-20 rounds

Flame Rounds : 10-20 rounds

Rocket Launcher : 10-20 rounds

Machine Gun : very much

-----  
WILLIAM 5  
-----

- Characteristics : an unshape mass with a lot of fatal tentacles. It has a big mouth and a lot of thorns around which can gulp anything. Attack by striking or cornering and gulp.

- Strategy : Shoot in calmness as fast as you can. Be careful with its

thorns and tentacles!

- Weak against : N/A

- Ammo to kill :

Handgun Bullets : N/A

Shotgun Shells : 15-20 shells

Bow Gun Arrows : N/A

Magnum Rounds : 7-15 rounds

Grenade Rounds : 7-15 rounds

Acid Rounds : 7-15 rounds

Flame Rounds : 7-15 rounds

Rocket Launcher : 1-3 shot

Machine Gun : N/A

\*\*\*\*\*

#### 14. R A N K I N G S Y S T E M

\*\*\*\*\*

Your ranking system is marked by a hidden score that you can't see in the game.

| RANKING | TIME           | SAVE          | FIRST AID SPRAYS |
|---------|----------------|---------------|------------------|
| A       | under 3 hours  | under 3 times | 1                |
| A       | under 3 hours  | N/A           | 2                |
| A       | under 3 hours  | more 3 times  | N/A              |
| B       | 3:01 to 5:30   | 3 or 5 times  | 2 or 3           |
| C       | 5:30 to 7:30   | about 9 times | 5                |
| D       | 7:30 to 9:30   | more 9 times  | more than 6      |
| E       | more than 9:30 | more 9 times  | more than 7      |

\* Notes : Ranking system also depends on how long you use special weapons which are rewarded to you by best result(Rocket Launcher, Gatling Gun, Machine Gun). The more you use them, the lower your ranking is. So if you want to obtain the best rank, restrict using those weapons as much as you can.

\*\*\*\*\*

#### 15. S E C R E T S

\*\*\*\*\*

A/ LOCKER KEY : used to open the locker in the dark room. Choose Original game \_ Normal difficulty. From the beginning to the police station, don't pick up any items, any ammo or any guns. When you reach the yard of station, go to the underground path, you'll meet zombie Brad Vickers. This zombie is very tough that isn't killed easily by Handgun. Use powerful weapon to kill him. You'll receive the key from his corpse. That locker has the characters's costumes.

+ Leon : There are two outfits. When he wears them, he changes his action in aiming Handgun (aim by one hand) and shoot faster.

+ Claire : There's only one outfit. But you'll receive the Colt S.A.A which is faster than your Handgun.

---WHO IS BRAD VICKERS ?-----

Brad Vickers was a S.T.A.R.S. member who appeared in Resident Evil 1.

He was very the guy who left his partners in the haunted Raccoon Forest and fled away. He has a nickname called "Chicken Heart", just as his coward.

The zombie Brad Vickers you saw now, is NOT only a funny additional episode Capcom gave you. The cause of this is related to Resident Evil 3 Nemesis. Get this game to know. But I can report to you like this :

"Jill Valentine - the veteran S.T.A.R.S. Member, didn't join her partners to go abroad, as she said she still had something to do in Raccoon City. On her way, she was pursued by Nemesis - a BOW given by Umbrella. This Nemesis chased her and killed Brad Vickers in front of her. Brad was killed at very this Police Station. But it seemed that he hadn't died. He survived, being a zombie which might be affected by the virus from Nemesis.

-----  
B/ BROKEN SCREEN : This is random trick. Try to find two certain points in your screen. Then use your Shotgun to shoot them. You can see the screen is broken at a moment. I have done this twice. It's funny but hard to do.

C/ UNLIMITED WEAPONS : You'll get some powerful unlimited weapons in original game with high rank. See "Weapon List".

D/ REBECCA'S SECRET PHOTO : In the S.T.A.R.S. office, check the desk near the S.T.A.R.S. poster (Wesker's desk) until some notes is written in the bottom of the screen. Press X for the notes to appear 50 times. You'll find the Film D. Bring it to the Dark Room to create the photo.

E/ EXTREME BATTLE MODE : Complete the two scenarios in Normal difficulty with A or B rank.

F/ HUNK'S SCENARIO : Try to have three empty spaces in your Memory Card, then complete 3 continuous scenarios with A rank in Normal difficulty and saved them fully. They mustn't be overwritten.

G/ TOFU'S SCENARIO : Try to have six empty spaces in your Memory Card, then complete 6 continuous scenarios with A rank in Normal difficulty and saved them fully. They mustn't be overwritten.

\*\*\*\*\*

## 16. E X T R E M E B A T T L E M O D E

\*\*\*\*\*

\* How to get this mode : See "Secrets" menu

=====  
A/ CHARACTERS AND WEAPONS  
=====

-----  
Leon Scott Kennedy  
-----

- H&K VP70 Handgun
- Remington M1100-P Shotgun
- Desert Eagle 50A.E
- Ink Ribbon



- First Aid Spray
- Blue herb

-----  
Claire Redfield  
-----

- M79 Grenade Launcher with Grenade Rounds
- Grenade Flame Rounds
- Grenade Acid Rounds
- Ink Ribbon
- First Aid Spray
- Blue herb

-----  
Chris Redfield  
-----

- Beretta-M92FS
- Remington M1100 Enhanced Shotgun
- Rocket Launcher
- Ink Ribbon
- First Aid Spray

-----  
Ada Wong  
-----

- Colt S.A.A. pistol
- MAC11 Machine Gun
- Bow gun
- Ink Ribbon
- Mixed Herb

NOTES :

- Leon and Claire are standard characters.
- Unlock Ada Wong by finishing Leon's mission with best result.
- Unlock Chris Redfield by finishing Claire's mission with best result.

=====  
B/ STRATEGY  
=====

- Mission: find 4 anti-virus bombs in the police station in a certain time.
- Where : from Laboratory area to Police Station precinct

GENERAL STRATEGY :

There are three levels of this scenario. The higher level is, the stronger enemies are. Each scenario includes :

- Stage 1 : Laboratory area
- Stage 2 : Fight to police precinct
- Stage 3 : Obtain 4 special bombs in police precinct

This is time scenario. That means you have to make records about the seeking time in each level.

In the first time, try to fortify your ammo and healing items by looking for and estimate them. If you feel that they're enough, don't pick up anymore. It's waste of time. This scenario has tons of ammo and herbs that you shouldn't worry about it. Avoid any enemies if you can, especially Mr.X, G-Infant, Lickers, etc . There are a lot of G-Infant and Mr.Xs in this scenario. Remember to be sure of your destination you're coming, don't go around too much to save time. All of your records will be saved, and then the best results can give you new

characters.

WHERE DO I FIND HERBS OR HEALING ITEMS :

~~~~~

Healing Items are random, too. But they can be in these positions :

- Stage 1 :
  - + Licker Experiment Room
  - + Infirmary
  - + Around the train
- Stage 2 :
  - + Control Room
  - + Leon's Weapon Storage
- Stage 3 :
  - + Waiting Room
  - + Power Room , basement
  - + Back courtyard
  - + Dark Room

INFINITE BLUE HERB BUSH LOCATION

- Stage 1 : Laboratory area center
- Stage 2 : Parking Lot
- Stage 3 : Main Hall 1st floor.

CHARACTER STRATEGY

~~~~~

-----  
Leon Scott Kennedy  
-----

Difficulty : Fairly Easy

- Best weapon is Remington M1100-P Shotgun. It has most ammo and appreciate with every enemies. Magnum is all right but it's hard to fight Lickers. If you can, dodge the enemies as much as you can.

- Zombies : Handgun, Shotgun, Magnum
- Dog Zombies : Handgun, Shotgun, Magnum
- Lickers/Super Lickers : Shotgun
- Black Widows : Shotgun, Magnum
- Small Spiders : Handgun, stepping.
- Crows : Handgun
- Plants : Shotgun
- G-Infant : Shotgun, dodging
- Mr.X : Shotgun, dodging

-----  
Claire Redfield  
-----

Difficulty : Easy

- She is lucky to have the Grenade Launcher which is very appreciate with every enemies. One shot can kill ordinary enemy. Try to do your best with this advantage. But I want to remind you that you should use Acid rounds with Lickers. If not, use Grenade rounds. Flame rounds sometimes hasn't effect with these.

- Zombies : Grenade Rounds, Flame Rounds, Acid Rounds
- Dog Zombies : Grenade Rounds, Flame Rounds, Acid Rounds
- Lickers/Super Lickers : Acid Rounds, Grenade Rounds
- Black Widows : Flame Rounds, Grenade Rounds
- Small Spiders : Stepping

Crows : Dodging  
Plants : Flame Rounds, Grenade Rounds  
G-Infant : Grenade Rounds, Flame Rounds, Acid Rounds, dodging  
Mr.X : Grenade Rounds, Flame Rounds, Acid Rounds, dodging

-----  
Chris Redfield  
-----

Difficulty : Medium

- It's Remington M1100 Enhanced Shotgun. Chris is a super marksman which is faster and correct in shooting. Sometimes your Beretta Handgun can splash zombies's heads with him. He can use this heavy Enhanced Shotgun very well and fast, not so slow as Leon does. Playing as Chris is not very hard, as your weapons are pretty powerful, enough to deal with the enemies.

Zombies : Handgun, Shotgun, Rocket  
Dog Zombies : Handgun, Shotgun, Rocket  
Lickers/Super Lickers : Shotgun  
Black Widows : Shotgun  
Small Spiders : Handgun, stepping.  
Crows : Handgun  
Plants : Shotgun, Rocket  
G-Infant : Shotgun, Rocket, dodging  
Mr.X : Shotgun, Rocket, dodging

-----  
Ada Wong  
-----

Difficulty : Fairly Hard

- This character is a bit hard. As Chris, she is very good at shooting. For ordinary enemies, just use Bow Gun which has tons of arrows. But for Lickers, try to do your best with the Machine Gun. Bow gun can only beat these creepy in short range. If you use Colt S.A.A., try to reload your gun frequently because its capacity only contains 6 bullets.

Zombies : Pistol, Machine Gun, Bow Gun  
Dog Zombies : Pistol, Machine Gun  
Lickers/Super Lickers : Machine Gun, Bow Gun, dodging  
Black Widows : Machine Gun, dodging  
Small Spiders : Handgun, stepping.  
Crows : Dodging  
Plants : Bow Gun, Machine Gun  
G-Infant : Dodging  
Mr.X : Dodging

=====  
C. FOUR ANTI-VIRUS BOMBS'S POSITIONS  
=====

I know that the positions of 4 anti-virus bombs are random. But by my long time experience, I think they could be four of these positions's :  
- Ben Bertolucci's cell  
- Watchman's room  
- TV Room  
- 3rd floor - Clock Tower  
- Meeting Room

- Guard Room
- S.T.A.R.S. office
- Sherry's first place

\*\*\*\*\*

## 17. HUNK & TOFU - THE 4TH SURVIVOR

\*\*\*\*\*

- How to get this mode : See "Secrets" menu
- Mission : steal G-virus from William Birkin for Umbrella Inc.
- Executed characters : Umbrella's salvage team
- Destination : go from Basement area to Police Station Heliport

### 1/ HUNK

Profile : Refer to "Character Bios" section.

- Weapon :
- H&K VP70 Handgun
  - Remington M1100-P Shotgun
  - Desert Eagle 50A.E Magnum

### 2/ TOFU

Profile : Refer to "Character Bios" section.

- Weapon : - Combat Knife

### \* General strategy :

Estimate your ammo and health, try to avoid any enemies you can, especially with Tofu. Combat knife is not a good weapon in this situation(but Tofu is stronger than other characters).

Well then, like The Extreme Battle Game, you take control of either character to get the target of the mission. You also begin from the Laboratory area to reach Police Station. Monsters are around everywhere, and you use the limited ammo you've got to keep yourself alive until the mission is ended. Got it ? But anyway, dodging as many as opponents you can, to save your ammo.

\*\*\*\*\*

## 18. GAME SHARK CODES

\*\*\*\*\*

### NOTES :

- This codes are got from other sources. The author of this guide never uses Game Shark Codes. So don't complain me if they don't work.

-----  
 CODES FOR CLAIRE REDFIELD  
 -----

- Unlimited Health 800C7C4200C8
- Start with Ink Ribbon in Box D013A2B20250  
800CCA58FFLE
- Start with Red Jewel in Box D013A2B20250  
800CCA500133
- Start with Cord in Box D013A2B20250

|                                             |                              |
|---------------------------------------------|------------------------------|
|                                             | 800CCA340147                 |
| - Start with Unicorn Medal in Box           | D013A2B20250<br>800CCA340147 |
| - Start with Eagle Medal in Box             | D013A2B20250<br>800CCA300148 |
| - Start with Wolf Medal in Box              | D013A2B20250<br>800CCA2C0149 |
| - Start with Special Key in Box             | D013A2B20250<br>800CCA240153 |
| - Start with Grenade Launcher in Box        | D013A2B20250<br>800CC95CFF09 |
| - Start with Grenade Launcher(Acid) in Box  | D013A2B20250<br>800CC960FF0A |
| - Start with Grenade Launcher(Flame) in Box | D013A2B20250<br>800CC964FF0B |
| - Start with Bow gun in Box                 | D013A2B20250<br>800CC968FF0C |
| - Start with Spark Shot in Box              | D013A2B20250<br>800CC970FF0E |
| - Start with Machine Gun in Box             | D013A2B20250<br>800CC974FF0F |
| - Start with Rocket Launcher in Box         | D013A2B20250<br>800CC978FF11 |
| - Start with Gatling Gun in Box             | D013A2B20250<br>800CC97CFF12 |

-----  
CODES FOR LEON SCOTT KENNEDY  
-----

|                                    |                              |
|------------------------------------|------------------------------|
| - Unlimited health                 | 800C7E7A00C8                 |
| - Start with Handgun Custom in Box | D00AAC8C1000<br>800CCB94FF04 |
| - Start with Magnum in Box         | D00AAC8C1000<br>800CCB98FF06 |
| - Start with Custom Magnum in Box  | D00AAC8C1000<br>800CCB9CFF06 |
| - Start with Shotgun in Box        | D00AAC8C1000<br>800CCBACFF0F |
| - Start with Custom Shotgun in Box | D00AAC8C1000<br>800CCBA4FF08 |
| - Start with Machine Gun in Box    | D00AAC8C1000                 |

|                                     |                              |
|-------------------------------------|------------------------------|
|                                     | 800CCBACFF0F                 |
| - Start with Flamethrower in Box    | D00AAC8C1000<br>800CCBB0FF10 |
| - Start with Rocket Launcher in Box | D00AAC8C1000<br>800CCBB4FF11 |
| - Start with Gatling Gun in Box     | D00AAC8C1000<br>800CCBB8FF12 |
| - Start with Ink Ribbon in Box      | D00AAC8C1000<br>800CCC90FF1E |
| - Start with Virgin Heart in Box    | D00AAC8C1000<br>800CCC78013B |
| - Start with Bishop Plug in Box     | D00AAC8C1000<br>800CCC78013B |
| - Start with Rook Plug in Box       | D00AAC8C1000<br>800CCC74013C |
| - Start with King Plug in Box       | D00AAC8C1000<br>800CCC6C013E |
| - Start with Knight Plug in Box     | D00AAC8C1000<br>800CCC70013D |
| - Start with Unicorn Medal in Box   | D00AAC8C1000<br>800CCC600148 |
| - Start with Eagle Medal in Box     | D00AAC8C1000<br>800CCC5C0149 |
| - Start with Wolf Medal in Box      | D00AAC8C1000<br>800CCC5C0149 |
| - Start with Special Key in Box     | D00AAC8C1000<br>800CCC540153 |

\*\*\*\*\*

## 19. R E L A T E D R E S I D E N T E V I L 2

\*\*\*\*\*

Resident Evil 2 Dual Shock Edition is the most complete version of Resident Evil 2 which has more mini-games. This version is also released for PC which has another menu named "Special". In this menu, you can review the intro or see the funny artwork of this game.

Okay, let's find out about the birth of Resident Evil 2.

=====

### A. RESIDENT EVIL 1.5

=====

The first version of Resident Evil 2 which was cancelled when it had been 70% completed because Shinji Mikami received new story. This version is hardly the same as current Resident Evil 2. These are the

difference :

- The main characters are Leon Scott Kennedy and Elza Walker. Elza Walker's characteristics are the same as Claire Redfield's but she has no relation with Chris Redfield. This character can change the whole story of Resident Evil series, currently Resident Evil Code Veronica (There's no adventure of Redfields to look for each other).
- Robert Kendo, Marvin Branagh appear longer in the game
- William monster is more terrible and "funny".
- The mansion, area design is different.
- Sherry's character design is rather different.
- The characters's portraits in menu screen are different.
- The menu screen is different
- ... ..

In addition to this, there are a lot of difference about story, roles, areas, items etc. Here I only tell you the representing ones.

Well, I'd like to tell you a few about Elza Walker too :

\*\* ELZA WALKER \*\*

I think she may be the same age as Claire's. She is pretty similar to Claire, but her hair is blonde. Claire loves riding motorcycle, but Elza is fond of riding horse and she is also an athlete of this sport either. According to some given information, Elza came to Raccoon City to participant a rising horse contest held here. But she didn't know anything about the zombies' appearances. Then she met Leon Scott Kennedy on the way and both of them try to overcome the nightmare...

=====

B. BIOHAZARD 2 BETA 1st

=====

This version is almost the same as current version. But it still has so many difference. The general ones are weapons, strange areas, etc. The menu screen seems more modern. The characters's portraits are different, too. Here I only tell you the representing ones which is in my knowledge about this game, also about language because I don't know much English:

| ~~~~~ ~~~~~                                                                               | ~~~~~ ~~~~~                                                                                   |
|-------------------------------------------------------------------------------------------|-----------------------------------------------------------------------------------------------|
| BIOHAZARD 2 BETA                                                                          | RESIDENT EVIL 2                                                                               |
| 1st VERSION                                                                               | DUAL SHOCK EDITION                                                                            |
| ~~~~~ ~~~~~                                                                               | ~~~~~ ~~~~~                                                                                   |
| - There is no mini-game.                                                                  | - There are some mini-games.                                                                  |
| - Has an assault rifle named MP5.                                                         | - Has no assault rifle.                                                                       |
| - Strange monster in Laboratory area.                                                     | - Has no strange monster.                                                                     |
| - In the corridor where you first meet a Licker, there's no headless corpse or gray door. | - In the corridor where you first meet a Licker, there are a headless corpse and a grey door. |
| - There is no knight statue between two lady relieves in Antique Room.                    | - There is a knight statue between two lady relieves in Antique Room.                         |
|                                                                                           |                                                                                               |

=====  
C. BIOHAZARD 2 BETA 2nd  
=====

This version seems newer than the first a few. There is some joke here, too.

General difference :

- Camera angles are different
- Decoration and design are different.
- Zombies are at different places.

Okay, let's go to specific :

~~~~~|~~~~~  
~~~  
BIOHAZARD 2 BETA | RESIDENT EVIL 2  
2nd VERSION | DUAL SHOCK EDITION  
~~~~~|~~~~~  
~~~

- |                                                                                                                                   |  |                                                                                              |
|-----------------------------------------------------------------------------------------------------------------------------------|--|----------------------------------------------------------------------------------------------|
| - There is another option named Debug Mode.                                                                                       |  | - There's no Debug Mode.                                                                     |
| - There is no mini-game.                                                                                                          |  | - There are some mini-games.                                                                 |
| - There is a typewriter in the gun shop.                                                                                          |  | - There's no typewriter in the gun shop.                                                     |
| - In the back way, the wall shows you the zombies inside.                                                                         |  | - In the back way, the wall doesn't have anything.                                           |
| - The streets are very clean and clear. There are fewer zombies.                                                                  |  | - The streets are full of waste and spoiled means. There are a lot of zombies.               |
| - There is an Item Box beside the Computer in the main hall of the Police station.                                                |  | - There's no Item Box there.                                                                 |
| - Leon talks to Marvin. When going out, he stands for a while and says : "I'll be back".                                          |  | - Leon talks to Marvin and goes out soon as Marvin's order.                                  |
| - Before Marvin is turned into a zombie, Leon sits down and asks what is happening to him.                                        |  | - Before Marvin is turned into a zombie, Leon does nothing.                                  |
| - In scenario B, Marvin was a zombie who is waiting for you when you return.                                                      |  | - In scenario B, Marvin was dead before you return.                                          |
| - In scenario B, when solving the puzzle in the TV Room, the wall was destroyed before you come. Then Mr.X comes in by that hole. |  | - In scenario B, after solving the puzzle in TV Room, Mr.X destroys the wall and attack you. |
| - There is a bear figure in                                                                                                       |  | - There's nothing in Chemist Room.                                                           |



|                                                                           |                                                                  |
|---------------------------------------------------------------------------|------------------------------------------------------------------|
| Iron's Chemist Room.                                                      |                                                                  |
|                                                                           |                                                                  |
| - There is no Black Widow in the second sewer path.                       | - There are a lot of Black Widows in sewer paths.                |
|                                                                           |                                                                  |
| - There is no blue herb in the bridge room.                               | - There is unlimited Blue Herb in the bridge room.               |
|                                                                           |                                                                  |
| - In some corridor in Factory, One of the wall's was destroyed.           | - There is nothing there.                                        |
|                                                                           |                                                                  |
| - The door of Fusion Room is clean.                                       | - The door of Fusion Room is full of fusible stains.             |
|                                                                           |                                                                  |
| - In the Fusion Room, there is some blue (cyan) air beside the white fog. | - The Fusion Room is full of white fog.                          |
|                                                                           |                                                                  |
| - There's no machine to turn the Fuse Case into Main Fuse.                | - There's a machine to turn the Fuse Case into Main Fuse.        |
|                                                                           |                                                                  |
| - In the Vaccine room, there's no machine to put Vaccine cart in.         | - In the Vaccine Room, there's a machine to put it in.           |
|                                                                           |                                                                  |
| - The "Licker corridor" has no Lickers. There are Plants.                 | - The Licker corridor has three Lickers.                         |
|                                                                           |                                                                  |
| - There is no table to put the MO disc to open the shutter.               | - There is a table to put the MO disc to open the shutter.       |
|                                                                           |                                                                  |
| - The Licker experiment room has naked zombies.                           | - The Licker experiment room has Lickers.                        |
|                                                                           |                                                                  |
| - There is a Moth near the Power Room area.                               | - There's no Moth there.                                         |
|                                                                           |                                                                  |
| - There is no Item Box and typewriter in the final train.                 | - There are an Item Box and Typewriter in the train.             |
|                                                                           |                                                                  |
| - No elevator in the final battle of scenario A.                          | - There is an escape elevator in the final battle of scenario A. |
|                                                                           |                                                                  |

~~~~~|~~~~~

\* What is Debug Mode ?  
 Debug Mode is an option that you can use to move place to place in the fastest way. Just because its special function, sometimes the characters can be moved to very incredible places, even on the wall.

\* Another difference :  
 Biohazard 2 beta has another difference. When you have finished all the four parts Leon A/B and Claire A/B of the game, later you can choose the scenario you want to play freely without a Save File.

=====

D. RESIDENT EVIL 2

=====

This is the most popular version of this game. The only difference between Resident Evil 2 and Resident Evil 2 Dual Shock Edition is that

it doesn't have Arrange Game (Rookie Mode) and Extreme Battle Mode.  
That's all. This version has been released for many platform :

- RESIDENT EVIL 2 FOR SONY PLAYSTATION : This was the most original version of Resident Evil 2, released for Playstation. It didn't have Arrange Game and Extreme Battle mini-game. But this version was basically completed.

- RESIDENT EVIL 2 FOR NINTENDO 64 : This was a pretty perfect version of Resident Evil 2. It has an optional violence level for the players to increase or decrease. Throughout the game, you can find many extra documents, called Ex Files which contains many plot information about the events in the story of Resident Evil.

- RESIDENT EVIL 2 FOR DREAMCAST : It's pretty similar to common version, with better graphic.

- RESIDENT EVIL 2 FOR PC : PC also has two versions : Regular and Dual Shock. They are all similar to the above versions, but they have an extra menu called "Special". In this menu, you can take a look at the characters' and monsters' artworks, the FMV scenes and 3D designs of the objects in the game. You collect the stuffs by playing through the game and meet those objects. Then they will be saved in "Special" menu. As you play on PC, the game has more optional functions than the versions of other consoles, such as controlling the smooth level of the screen, highlight the objects and so on.

- RESIDENT EVIL 2 FOR GAMECUBE : At this time, when I write this guide, it's still the future. But we can be sure that it will have much better graphic and even new enemies and episodes, like Capcom did with Resident Evil Reborn.

\*\*\*\*\*

## 20. MISCELLANEOUS

\*\*\*\*\*

I open this menu for reminding the players who are new to this game feeling confusing how to play best. Hope this part is useful for you.

~~~~~\  
CHARACTERS'BEGINNING \~~~~~  
~~~~~

- If you play this dual shock version, there are some difficulties :

+ Original game :

\_ Easy mode :- Leon starts with : Combat knife, VP70 Handgun with 18 bullets and 147 handgun bullets.

- Claire starts with : Combat knife, Browning HP handgun with 13 bullets and 147 handgun bullets.

\_ Normal Mode :- Leon : Combat knife and 18 bullet-VK70 Handgun

- Claire : Combat knife and 13 bullet-browning HP handgun

+ Arrange game : game for rookie, beginning item is an unlimited Machine Gun. In addition to this, there are unlimited Gatling Gun, Rocket Launcher and the character's own weapons in the item box.

- Leon's standard item is the Lighter.

- Claire's standard item is Lockpick.
- Ada's item is a Browning HP, Handgun bullets, First Aid Spray and her standard item is a picture of her and another man (maybe it's John)
- Sherry's item is a First Aid Spray and her standard item is a picture of her family.

~~~~~\  
 GENERAL STRATEGY \~~~~~  
 ~~~~~

- See "Monster List" to know more about tactics for each enemy. The most general is keeping the best distance.
- Any tactics are appreciate, not only mine. But the important thing is that you are in safest condition.
- Draw your weapon correctly before take out an enemy. Resident Evil 2 doesn't have auto-draw.
- Always clever and fast in fighting the dangerous bosses.
- Frequently grab healing items ever you don't use them curreltly. They're very important to you later.
- Keep calmness in every situation.
- If you are new, try to collect the files you see on your way. Sometimes they are useful.

~~~~~\  
 DIFFERENCE BETWEEN LEON & CLAIRE \~~~~~  
 ~~~~~

This menu lets you know about the difference between the scenarios of each character which involved the game strategy. That means this menu doesn't contain the clearly difference such as specific weapons, items, biography etc.

There are 4 parts :

-----  
 --  
 PART 1 : BASIC DIFFERENCE BETWEEN LEON AND CLAIRE  
 -----  
 --

LEON SCOTT KENNEDY

CLAIRE REDFIELD

- |                                                            |                                                    |
|------------------------------------------------------------|----------------------------------------------------|
| - Supporter : Ada Wong                                     | - Supporter : Sherry Birkin                        |
| - Related : Ben Bertolucci                                 | - Related : Brian Irons                            |
| - Doesn't have to find Bomb & Detonator.                   | - Must find Bomb & Detonator to open Chief's room. |
| - Find Heart Key at Marvin's place                         | - Find Heart Key at Chief Iron's place.            |
| - Find the four Plugs to unlock the sewer passage.         | - Find the three stones to unlock Sewer passage.   |
| - He explores the left area of the basement (Parking Lot). | - She explores the right area of the basement.     |
| - When seeking Club Key, Ada gets                          | - When seeking Club Key, Sherry gets               |

ammo for Leon at the place where Sherry began.

- He explores the north east of sewer sewer area.

- First meet Annette at Sewer 1.

- Doesn't have to find Lighter

ammo for Claire at the place where Ada began.

- She explores the south east of area.

- First meet Annette at Sewer 2.

- Doesn't have to find Small Key

-----  
--

PART 2 : GENERAL BASIC DIFFERENCE BETWEEN SCENARIO A & B

-----  
--

SCENARIO A

- Big bosses : G-Infant, William 2, William 4 and Alligator.

- The character can't explore all the places the B one has gone.

- The zombies destroy windows and dart in when the character returns to Library second time.

- Begin from the street to the front gate of Police Station.

- Valve Handle is at the back courtyard.

- Blue Card Key is got from Marvin.

- Unicorn Medal is hidden under Chris's diary.

- Lighter is at Waiting Room.

- Diamond Key is at Antique position room.

- There is a cord.

- Crank is in File Room.

- Machine Gun is at Weapon Storage only.

SCENARIO B

- Big bosses : William 1, William 3, William 5 and Mr.X.

- The character can explore all entire the places the A one has gone.

- The zombies destroy the windows and dart in when the character first goes to the Library.

- Begin from the street to the back gate of Police Station.

- Valve Handle is at east office.

- Blue Card Key is at Antique Room.

- Unicorn Medal is on the wall of 2F main hall.

- Lighter is at File Room.

- Diamond Key is at different

- There's no cord.

- Crank is at different positions.

- Machine Guns are at Weapon Storage And Licker experiment room.

- The character can't enter the laboratory elevator.

- The character can enter the Laboratory elevator.

- The character can't enter the Licker experiment room.

- The character can enter the Licker Experiment room (depending on the A character).

- Doesn't have to find Power make Room Key and Master Key.

- Doesn't have to find MO disk or Vaccine, it means Lab Card Key is an Unnecessary item.

-----

--

PART 3 : DIFFERENCE BETWEEN LEON A & CLAIRE A

-----

--

LEON SCENARIO A

CLAIRE SCENARIO A

- Get Wolf Medal from the corpse.

- Get Wolf Medal from Sherry.

- Next meeting with Annette is at West area of Laboratory B4.

- Next meeting with Annette is at the door of William's experiment room, Laboratory B5.

- Doesn't have to make G-Vaccine

- Has to make G-Vaccine.

-----

--

PART 4 : DIFFERENCE BETWEEN LEON B & CLAIRE B

-----

--

LEON SCENARIO B

CLAIRE SCENARIO B

- Grab the Diamond Key from Sherry.

- Grab the Diamond Key in S.T.A.R.S. Office.

- When seeking Club Key, Ada gets the pendant from Sherry.

- Sherry doesn't drop the pendant.

- Grab the Crank in Sherry's first place.

- Grab the Crank in dog's cage area.

- Second meeting with Annette is at the Laboratory elevator.

- Second meeting with Annette is at Monitor Room, Laboratory B5.

- Get Master Key from Ada.

- Get Master Key from Annette.

~~~~~\  
QUICK STRATEGY \~~~~~  
~~~~~

This strategy is for expert players who want to get high rankings or make records about time.

- Run as fast as you can
- Avoid any enemies you can.

- Don't waste time to get all ammo you've passed. Resident Evil 2 is not poor enough for you to die.
- Don't get the files when you know them too much. I have written them all here. It's a waste of time either.
- Determine your certain place you really want to go, don't wander.
- Determine your certain work you are going to do next.
- Use powerful weapons more frequently when you have it and its ammo.
- Secret places or episodes don't affect your ranking. Don't mention them when you want to make a record of ranking.

~~~~~\  
 SPEED WALKTHROUGH \~~~~~  
 ~~~~~

\*IMPORTANT NOTES

- In the walkthrough I list the order of the work you do in the most fastest and convenient way. But maybe it's just fastest in my opinion. Any ideas, please contact me at my email address. This walkthrough is mainly used for Normal Mode. Use this combining with Quick Strategy above. And of course, to use this walkthrough, you must be a person who is very good at arranging items in your inventory. I can't spoil this guide by many details. I think you would have your own way to play.

=====  
 LEON SCENARIO A  
 =====

-----  
 STREETS  
 -----

- Talk to Kendo, then grab ammo and get out soon.
- Get ammo in the path, pass the basket ball yard and continue.
- Ignore the group of eating zombies and get on the bus.
- Kill the two zombies and get off. Try to use all your agility here to get pass these guys.
- Enter RPD Police Station.

-----  
 RPD POLICE STATION  
 -----

- Avoid two zombies
- Talk to Marvin and access the Blue Card Key
- Open the west door
- Reach the Meeting Room and grab a Virgin Heart.
- Go up to 2nd floor, grab the 2nd Virgin Heart.
- In the STARS office, get Shotgun and Unicorn Medal.
- Return to the main hall and put the Unicorn Medal on the woman statue and grab Spade Key.
- Unlock the File Room and take Crank.
- Unlock the room beside STARS office, kill the zombies by Shotgun, grab ammo and continue.
- Solve the puzzle in the Library to get Bishop Plug.
- In the 2nd floor hall, open the emergency ladder but don't climb now.
- Pass the waiting room and go to dark corridor.
- Fight the crows and get to the heliport.
- Avoid the zombies in the courtyard, grab the Valve Handle and DON'T OPEN THE NEXT DOOR. Just return to put out the fire.
- Go to the Antique Room, put the two Virgin Hearts, grab King Plug and Diamond Key.
- Use emergency ladder to get down. Get to the east area again and use Diamond Key to get to Marvin's place.

- Fight Marvin and grab Heart Key.
- Now let's get to the west area, use Diamond Key to open the interview room and grab Rook Plug.
- Open the safe in the office if you want.
- Use Heart Key to get down the basement.

-----

- Get inside the Power Room and supply power to the Weapon Storage.
- Go to the Parking Lot, then find Ben and talk to him.
- Grab the Manhole Opener, go to the dog cages area.
- Get down the sewer, pass the Black Widows and go on the ground.
- Use the three Plugs to put on the door to sewer, then get out to find Ada.
- Control Ada to find the Club Key and Shotgun Shells, then return and give them to Leon.
- Return to the basement corridor, use Club Key to open Autopsy Room.
- Grab Red Card Key and fight the zombies.
- Use the card to unlock the Weapon Storage. Grab ammo and Machine Gun. The Side Pack is optional.
- Return to the 1st floor.

-----

- Go to Watchman's room to get Magnum and Shotgun Shells.
- In west area, find the TV room and unlock it. Solve the puzzle to grab Golden Cogwheel.
- Return to the Library. From Library go to 3rd floor.
- In the clock room, use the Crank to lower the secret stairs. Then go up and put the Golden Cogwheel in the hole.
- Get Knight Plug and jump down the rusty way.
- Meet Ben to get "Mail to Chief". Then return to the place where you put the Plugs.
- Fight G-Infant by the Machine Gun.
- Put the last Plug to get out of Police Station.

-----

#### SEWER

-----

- Go to the Control Room. Bring the Valve Handle with you. Don't go to the ammo storage or it's just a waste of time.
- After seeing Annette, chase after her and talk.
- Control Leon to the sewer paths. Grab Wolf Medal from the corpses and get to the bridge room. Use Valve Handle here.
- Pass the bridge to the next hall.
- Fight the Alligator by the strategy I said in full walkthrough. Then talk to Ada.
- Get on Sewer B1 to find Eagle Medal.
- Return to the waterfall. Put the two medals on the machine to stop it.
- Get on the train to factory.
- Play with William's hand. If you don't want to waste ammo, just run around and let Ada handle it.

-----

#### VACANT FACTORY

-----

- Fight the zombies, get Shotgun Part from the corpse.
- Pass the two corridors until coming to the Save Room. Prepare yourself carefully.
- Go into the train first to grab the Control Panel Key. Then go out and put it on the table.
- Push the activation switch. Get down to Laboratory area.

- Fight William 2 by Enhanced Shotgun or Magnum.

-----  
LABORATORY AREA  
-----

- Go to the laboratory west area. Go to the Fusion room to get Fuse Case.
- Put the Fuse Case in the machine to receive Main Fuse.
- Put Main Fuse in the area center to supply power to the whole laboratory.
- Go to the east area. Grab the Flamethrower and Shotgun Shells.
- Open the shutter, use the Flamethrower to fight the Humanoid Plants.
- In the small balcony, climb down the ladder.
- Kill the Super Lickers in the corridor. Head to Monitor Room, then William's experiment room.
- Grab Lab Card Key and get out.
- Return to the west area. Use Lab Card Key to open the Vaccine making room.
- Grab MO Disc.
- Return to the Licker Corridor, use Mo Disc to open the shutter.
- Fight the final boss. Then escape as soon as possible by the emergency elevator.
- Go to the train to meet Claire Redfield.

=====  
LEON SCENARIO B  
=====

-----  
STREET  
-----

- Avoid the zombies and run to the back gate of Police Station.

-----  
RPD POLICE STATION  
-----

- Avoid the three zombies, take Cabin Key in the guardroom and use it to get in the main courtyard.
- Grab ammo, avoid the four zombies and get on the heliport to see a FMV scene.
- Kill the crows in dark corridor. Then unlock the door to the back stairs. Get down the eastern office.
- Avoid the zombies if you can. Grab the Valve Handle.
- Return, pass the Waiting Room to 2nd floor main hall. Use emergency ladder to get down to 1st floor.
- Grab the Shotgun with you.
- Return and put out the fire. Grab ammo and then fight Mr.X in the dark corridor.
- Go to Antique Room to have Blue Card Key.
- Head to 1st floor main hall, use the Blue Card Key to access the computer, unlock the doors.
- Climb up 2nd floor and get in the Library.
- Solve the puzzle to get Bishop Plug.
- You meet Sherry in the next room. Take the Diamond Key from her. Then talk to Claire.
- In the STARS office, get Magnum.
- Solve the statue puzzle to get one Virgin Heart.
- Reach the Meeting Room to take the other Virgin Heart.
- Use Diamond Key to get to Marvin's place. Find Heart Key.
- Climb up the ladder to 2nd floor. Go to Antique Room.



- Put the two Virgin Hearts to take King Plug.
- In the 1st floor main hall, go to the east area and unlock the interview room. Get Rook Plug.
- In the office, unlock the safe if you want. Then use Heart Key to get down the basement.

-----

- In the Power Room, supply electric power to the Weapon Storage.
- Kill the zombies here. Get to the Parking Lot.
- Find Ada and Ben and talk to them, then grab the Manhole Opener.
- Go to dog cages area and open the lid to sewer.
- Pass the Black Widows and go on the ground.
- Use the three Plugs to put on the door to sewer, then get out to find Ada.
- Control Ada to find the Club Key and Shotgun Shells, then return and give them to Leon.
- Return to the basement corridor, use Club Key to open Autopsy Room.
- Grab Red Card Key and fight the zombies.
- Use the card to unlock the Weapon Storage and grab what you want.
- Return to the 1st floor.

-----

- Go to Watchman's room to get Magnum and Shotgun Shells.
- In west area, find the TV room and unlock it. Solve the puzzle to grab Golden Cogwheel. Here you fight Mr.X two times.
- Go to Chief Iron's place which was opened by Claire. Find the Crank. Then Mr.X visits you again.
- Return to the Library. From Library go to 3rd floor.
- In the clock room, use the Crank to lower the secret stairs. Then go up and put the Golden Cogwheel in the hole.
- Get Knight Plug and jump down the rusty way.
- Meet Ben to get "Mail to Chief". Then return to the place where you put the Plugs.
- Fight William 1 by Magnum or Shotgun.
- Put the last Plug to get out of Police Station.

-----

#### SEWER

-----

- Go to the Control Room. Bring the Valve Handle with you. Don't go to the ammo storage or it's just a waste of time.
- After seeing Annette, chase after her and talk.
- Control Leon to the sewer paths. Grab Wolf Medal from the corpses and get to the bridge room. Use Valve Handle here.
- Pass the bridge to the next hall.
- Find and talk to Ada.
- Get on Sewer B1 to find Eagle Medal.
- Return to the waterfall. Put the two medals on the machine to stop it.
- Get on the train to factory.
- Play with William's hand. If you don't want to waste ammo, just run around and let Ada handle it.

-----

#### VACANT FACTORY

-----

- Fight the zombies, get Shotgun Part from the corpse.
- Pass the two corridors until coming to the Save Room. Prepare yourself carefully.
- Get out the Save Room, get down the lift to Monitor Room of the factory and get Control Panel Key. Fight Mr.X.

- Put the key onto the machine which Ada is using. Then get on the train outside.
- Fight William 2 by Enhanced Shotgun or Magnum.

-----  
LABORATORY AREA  
-----

- Go out of the train to check, until you see a hole. Go to it and you are suddenly trapped to Laboratory B1. The main elevator doesn't work.
- Get into the Pump Room. Get down the lift and use another elevator in the right path.
- Fight the Super Lickers, then move the activation switch of the elevator.
- Get out by the main elevator.
- Go to the laboratory west area. Go to the Fusion room to get Fuse Case.
- Put the Fuse Case in the machine to receive Main Fuse.
- Put Main Fuse in the area center to supply power to the whole laboratory.
- Go to the east area. Grab the Flamethrower and Shotgun Shells.
- Open the shutter, use the Flamethrower to fight the Humanoid Plants.
- In the small balcony, climb down the ladder.
- Kill the Super Lickers in the corridor. Head to Monitor Room, then William's experiment room.
- Grab the Power Room Key.
- Return to Laboratory B1. Solve the puzzle here to push the box that takes you to the Power Room.
- There you get Master Key from the film.
- After being asked by Claire, return to the infirmary in B4 area to bring Sherry with you.
- Use Master Key to get down to the train with Sherry.

-----  
FINAL TRAIN  
-----

- Go to the back of the train to get Platform Key.
- Get out of the train. Use Platform Key to open the door to next area.
- Take the two Plugs, then pass the stairs to the other side.
- In the last area, put the two Plugs to the machine. Then fight the last battle with Mr.X. See strategy at full walkthrough or Monster List.
- Return to the train. Go to the front to activate the train.
- After the scene, head to the back and fight the last form of William.

=====  
CLAIRE SCENARIO A  
=====

-----  
STREETS  
-----

- Talk to Kendo, then grab ammo and get out soon.
- Get ammo in the path, pass the basket ball yard and continue.
- Ignore the group of eating zombies and get on the bus.
- Kill the two zombies and get off. Try to use all your agility here to get pass these guys.
- Enter RPD Police Station.

-----  
RPD POLICE STATION

- 
- Avoid two zombies
  - Talk to Marvin and access the Blue Card Key
  - Open the west door and go.
  - Go up to 2nd floor, grab the 2nd Virgin Heart.
  - In the STARS office, get Grenade Launcher and Unicorn Medal.
  - Return to the main hall and put the Unicorn Medal on the woman statue and grab Spade Key.
  - Unlock the File Room and take Crank.
  - Unlock the room beside STARS office, kill the zombies by Grenade Launcher, grab ammo and continue.
  - Solve the puzzle in the Library to get Serpent Stone.
  - In the 2nd floor hall, open the emergency ladder but don't climb now.
  - In the Waiting Room, get the Lighter.
  - Climb down the emergency ladder, head to Meeting Room to get Virgin Heart. Then return to Waiting Room by this ladder.
  - Pass the fire and go to the dark corridor.
  - Fight the crows and get to the heliport.
  - Avoid the zombies in the courtyard, grab the Valve Handle and Bow Gun. But DON'T OPEN THE NEXT DOOR. Just return to put out the fire.
  - Go to the Antique Room, put the two Virgin Hearts, grab Blue Stone and Diamond Key.
  - Use emergency ladder to get down. Head to west area again.
  - Use Diamond to enter Locker Room. Fight the zombies by Grenade Launcher.
  - Find the Bomb beside the next door.
  - Fight Marvin and grab Detonator. Combine it with Bomb.
  - Use the ladder to climb to 2nd floor. Use Bomb & Detonator to explode the path beside the helicopter.
  - Go to the new area and talk to Chief Iron.
  - Then find and talk to Sherry.
  - Return to Chief Iron and grab Heart Key.
  - Now let's get to the west area, use Diamond Key to open the interview room and grab Eagle Stone.
  - Open the safe in the office if you want.
  - Use Heart Key to get down the basement.

- 
- Get inside the Power Room and supply power to the Weapon Storage.
  - Go to the north door, try to avoid the dogs and climb down the ladder.
  - Find Sherry and talk to her.
  - Control Sherry to find the Club Key and ammo, then return and give them to Claire.
  - Return to the basement corridor, use Club Key to open Autopsy Room.
  - Grab Red Card Key and fight the zombies.
  - Use the card to unlock the Weapon Storage. Grab ammo and Machine Gun. The Side Pack is optional.
  - Return to the 1st floor.

- 
- Go to Watchman's room to get ammo.
  - In west area, find the TV room and unlock it. Fight the Licker.
  - Solve the puzzle to grab Golden Cogwheel.
  - Return to the Library. From Library go to 3rd floor.
  - In the clock room, use the Crank to lower the secret stairs. Then go up and put the Golden Cogwheel in the hole.
  - Get Blue Stone. Combine it with the other Blue Stone to make Jaguar Stone.
  - Return to Chief Iron's room. Sherry is here.
  - Push the switch below the picture behind the chair. Then put the three stones in the holes.

- Get down the elevator and talk to Iron.
- Descend the next ladder. Fight G-Infant by the Machine Gun.
- Return to take Sherry with you.
- Put the switch to lower the last ladder here. Get out of Police Station.

-----  
SEWER  
-----

- Take control of Sherry and try to reach the dump area.
- After Sherry is lost, you return to Claire. Go to the Control Room. Bring the Valve Handle with you. Don't go to the ammo storage or it's just a waste of time.
- Get to the bridge room. Use Valve Handle here.
- Pass the bridge to the next hall.
- Fight the Alligator by the strategy I said in full walkthrough. Then talk to Sherry and grab Wolf Medal.
- Get on Sewer B1 to find Eagle Medal.
- Return to the waterfall. Put the two medals on the machine to stop it.
- Get on the train to factory.

-----  
VACANT FACTORY  
-----

- Fight the zombies.
- Pass the two corridors until coming to the Save Room. Prepare yourself carefully.
- Go into the train first to grab the Control Panel Key. Then go out and put it on the table.
- Push the activation switch. Get down to Laboratory area.
- Fight William 2 by Grenade Launcher with Flame Rounds.

-----  
LABORATORY AREA  
-----

- Go to the laboratory west area. Go to the Fusion room to get Fuse Case.
- Put the Fuse Case in the machine to receive Main Fuse.
- Put Main Fuse in the area center to supply power to the whole laboratory.
- Go to the east area. Grab ammo here.
- Open the shutter, fight the Humanoid Plants by Flame Rounds.
- In the small balcony, climb down the ladder.
- Kill the Super Lickers in the corridor. Head to Monitor Room, then William's experiment room.
- Grab Lab Card Key and get out.
- Return to the west area. Use Lab Card Key to open the Vaccine making room.
- Grab MO Disc and Vaccine Cartridge.
- Put the Vaccine Cartridge into the computer. Then push the switch at the V.A.M. machine.
- Grab Base Vaccine and go to William's experiment room in the east area.
- Create Vaccine. Then return to the Licker Corridor, use MO Disc to open the shutter.
- Fight the final boss. Then escape as soon as possible by the emergency elevator.
- Go to the train to meet Leon Scott Kennedy.

=====  
CLAIRE SCENARIO B  
=====

-----  
STREET  
-----

- Avoid the zombies and run to the back gate of Police Station.

-----  
RPD POLICE STATION  
-----

- Avoid the three zombies, take Cabin Key in the guardroom and use it to get in the main courtyard.
- Grab ammo, avoid the four zombies and get on the heliport to see a FMV scene.
- Kill the crows in dark corridor. Then unlock the door to the back stairs. Get down the eastern office.
- Avoid the zombies if you can. Grab the Valve Handle.
- Return, pass the Waiting Room to 2nd floor main hall. Remember to take the Lighter. Use emergency ladder to get down to 1st floor.
- Grab the Grenade Launcher with you.
- Return and put out the fire. Grab ammo and then fight Mr.X in the dark corridor.
- Go to Antique Room to have Blue Card Key.
- Head to 1st floor main hall, use the Blue Card Key to access the computer, unlock the doors.
- Climb up 2nd floor and get in the Library.
- Solve the puzzle to get Serpent Stone.
- In the STARS office, get Bow Gun and Diamond Key.
- Solve the statue puzzle to get one Virgin Heart.
- Reach the Meeting Room to take the other Virgin Heart.
- Use Diamond Key to unlock Locker Room. Search for Bomb.
- Get to Marvin's place. Find Detonator and combine it with Bomb.
- Climb up the ladder to 2nd floor. Go to Antique Room.
- Put the two Virgin Hearts to take Blue Stone.
- Use Bomb & Detonator to get to Chief Iron's room and talk to him.
- Find Sherry and talk to her either. Then return to the Chief to get Heart Key.
- In the 1st floor main hall, go to the east area and unlock the interview room. Get Eagle Stone.
- In the office, unlock the safe if you want. Then use Heart Key to get down the basement.

- 
- In the Power Room, supply electric power to the Weapon Storage.
  - Kill the zombies here. Get through the north door.
  - Climb down the ladder and find Sherry.
  - Control Sherry to find the Club Key and ammo, then return and give them to Claire.
  - Return to the basement corridor, use Club Key to open Autopsy Room.
  - Grab Red Card Key and fight the zombies.
  - Use the card to unlock the Weapon Storage and grab what you want.
  - Head to Parking Lot which was opened by Leon and Ada, go to dog cages area to find Crank.
  - Return to the 1st floor.

- 
- Go to Watchman's room to get ammo.
  - In west area, find the TV room and unlock it. Solve the puzzle to grab Golden Cogwheel. Here you fight Mr.X two times.

- Return to the Library. From Library go to 3rd floor.
- In the clock room, use the Crank to lower the secret stairs. Then go up and put the Golden Cogwheel in the hole.
- Get Blue Stone and create Jaguar Stone.
- Return to Chief Iron's place. Sherry is here.
- Push the switch to move the picture. Then put the three stones onto the holes.
- Get down the elevator. Talk to Brian Iron.
- Fight William 1 by Grenade Launcher.
- Return to take Sherry with you. Then use the last ladder to get out of Police Station.

-----  
SEWER  
-----

- After Sherry is lost, go to the Control Room. Bring the Valve Handle with you. Don't go to the ammo storage or it's just a waste of time.
- Go to the sewer paths. Grab Wolf Medal from the corpses and get to the bridge room. Use Valve Handle here.
- Pass the bridge to the next hall, then the dump area.
- Get on Sewer B1 to find Eagle Medal.
- Return to the waterfall. Put the two medals on the machine to stop it.
- Take Sherry with you. Get on the train to factory.

-----  
VACANT FACTORY  
-----

- Fight the zombies here.
- Pass the two corridors until coming to the Save Room. Prepare yourself carefully.
- Get out the Save Room, get down the lift to Monitor Room of the factory and get Control Panel Key. Fight Mr.X.
- Put the key onto the machine in Save Room. Then get on the train outside.
- Fight William 2 by Grenade Launcher with Flame Rounds.

-----  
LABORATORY AREA  
-----

- Go out of the train to check, until you see a hole. Go to it and you are suddenly trapped to Laboratory B1. The main elevator doesn't work.
- Get into the Pump Room. Get down the lift and use another elevator in the right path.
- Fight the Super Lickers, then move the activation switch of the elevator.
- Get out by the main elevator.
- Go to the laboratory west area. Go to the Fusion room to get Fuse Case.
- Put the Fuse Case in the machine to receive Main Fuse.
- Put Main Fuse in the area center to supply power to the whole laboratory.
- Go to the east area.
- Open the shutter, use Flame Rounds to fight the Humanoid Plants.
- In the small balcony, climb down the ladder.
- Kill the Super Lickers in the corridor. Head to Monitor Room, then William's experiment room.
- Grab the Power Room Key.
- Return to Laboratory B1. Solve the puzzle here to push the box that

takes you to the Power Room. See the event here.

- Return to Laboratory B4 where Sherry is. There you get Master Key.
- Use Master Key to get to the train with Sherry.

-----  
FINAL TRAIN  
-----

- Go to the back of the train to get Platform Key.
- Get out of the train. Use Platform Key to open the door to next area.
- Take the two Plugs, then pass the stairs to the other side.
- In the last area, put the two Plugs to the machine. Then fight the last battle with Mr.X. See strategy at full walkthrough or Monster List.
- Return to the train. Go to the front to activate the train.
- After the scene, head to the back and fight the last form of William.

\*\*\*\*\*

21. FREQUENTLY ASKED QUESTIONS

\*\*\*\*\*

QUESTION : How much time does it take to complete a scenario ?

ANSWER : About 2-3 hours. If you are an expert, you can finish one scenario just after two hours of playing it continually.

-----  
QUESTION : I have beaten LeonA then ClaireB. How do I do to start ClaireA then LeonB ?

ANSWER : Input Claire disc and start New Game. It is ClaireA scenario.

-----  
QUESTION : Why don't you write the secret how to get Akuma ?

ANSWER : It was a fake code which had been used in an April Fool day.

-----  
QUESTION : Who is Akuma ?

ANSWER : Akuma is a playable character in the famous fighting game series Street Fighter of Capcom. I don't know about him. And this guide isn't made for Street Fighter.

-----  
QUESTION : I couldn't unlock Extreme Battle mini-game ?

ANSWER : This minigame is only available for Dual Shock version. You may be playing the regular version.

\*\*\*\*\*

22. OTHER STUFFS

\*\*\*\*\*

This is for anyone who anyone who wants to know about the full story of Resident Evil series. You can read this to collect hints about

the game, such as the real story of Resident Evil 2 is Leon A/Claire B.

~~~~~  
TREVOR'S NOTE  
~~~~~

#### INTRODUCTION & EXPLANATION

George Trevor was the architect who designed the mansion in Resident Evil 1 as the command of a mysterious guy named Spencer. Once he was invited to the house he built and then lost in it mysteriously. This is a story part got from the book "The True Story Behind Biohazard" which was published by Capcom in 1996. But the company saw that they have revealed too much for the players. So it was cancelled and most of us don't know about it. This Trevor's Note is translated directly into English.

#### INTRODUCTION OF TREVOR'S NOTE

Raccoon City

A city in the Western part of America. Within a deep forest on the outskirts of this city there is a mansion, which seems strangely quiet.

November 13th 1967

A man was standing in front of the mansion. It was George Trevor, a famous architect from New York, who had designed this place from scratch. The owner of the mansion, Ozwell E. Spencer, had invited him with all his family in order to thank him for the level of the perfection in his work.

Overloaded with work, Trevor initially sent his wife Jessica and her 14 year old daughter Lisa before joining them later. Unfortunately, when Trevor arrived on the spot, he didn't find his wife nor the child. Trevor too would mysteriously disappear upon entering the mansion.

Where could they all have disappeared to then ?

The following comes from a small diary written while Trevor was in the mansion. Spencer paid a fortune for this mansion. The construction alone took 5 years of Trevor's life. Why did he devote so much time to it ? And did Trevor already know that thirty years later other strange things would happen in this mansion ? Personally I feel that this small diary will be the key to understand all these mysteries.

#### TREVOR'S LETTER

November 13th 1967

After having finished my work and leaving New York I finally arrived at the Mansion around 6.00pm. The hall is very spacious. The central stairs leading to the second floor are also impressive. All these things make me nostalgic all over again.

Designing the plans of this place is the work I'm most proud of.

From the day I first showed the model to Ozwell E. Spencer in his office, until the completion of the building, took me 5 years. Spencer's orders were really difficult and I had to call upon all of my energy and ingenuity to realize it.

At first sight no one would suspect anything to be out of the ordinary. While turning to face me, Lord Spencer shakes the white hairs from his shoulders.

He has an impressive stature, and at the first glance, one can feel that he has a high level of self-confidence. He initially announces me that my wife Jessica and my daughter returned to visit their aunt Emma, who is ill, and then we lift our glasses and toast. We are only ones to know about the numerous secrets contained within this building. Deeply



satisfied with the complicity, we taste the wine.

The dining room is amazing. There is an incredible variety of food laid out harmoniously on a large table in mahogany wood. When someone would raise their eyes, they could see a statue of a goddess, in "Rodin" style, on the second floor which seems to observe us with desire. But despite all this splendor, the banquet can only be enjoyed by two guests (Spencer and I). We only hear the quiet clicking noise of the clock needles. Ahhh, if only Jessica and Lisa were there.

According to Spencer, they arrived three days before me and appreciated the house well. Lisa in particular benefited from the Spencer's kindness and was able to use the piano among others. She reportedly played the "Moonlight Sonata" of Beethoven (her specialty). In this evening of full moon where the melody seemed to surpass the satellite floating above the forest which surrounds the house, Spencer had congratulated my wife for this superb moment. I imagine proudly that their two faces had to be illuminated with pleasure.

November 14th 1967

Lord Spencer guided me around in the mansion. He opened the doors of several rooms. Those rooms are decorated with the most marvelous art pieces : painting of de Vinci, sculpture of Raphael...

In one of the rooms the eye of a stuffed beast has strangely sparkled, and in another room armors of Middle Age Knights were aligned in good order close to their captain.

All these art pieces were collected by Lord Spencer during past years and he deserves well to be one of the richest men on earth.

"Do you like that ? I wish to use this residence as a seaside resort, for a new company. I foresaw that, not only for the employees, but also for the guests could use it."

His project is to design an international industrial medicine company. He told me that its company would be called "Umbrella". But I wonder why he hid as many things in his residence. He can say that he wants to make a seaside resort but it's exaggerated. Even in the case his actions had been led by his passion.

November 18th 1967

My family hasn't come back yet. "Is aunt Emma that sick ?". I doubt it. The telephone is not installed, which is not very convenient. I went out to second floor terrace to clear my mind. Crows, perched on a rail, looked at me and pushed strange croaking.

I had a dark intuition. I continuously have the strange impression of being observed... I saw an astonishing thing, in a small court. It is a ladder leading down into an underpass, which is masked by a waterfall."It is not my work. When was this thing built then ?"

November 20th 1967

There is no trace of the shotgun my wife had offered Spencer for his birthday. I'm smoking a cigarette in the room where a broken shotgun can be found and estimate that it can fool people and pass for the original. I wonder who exchanged Spencer's shotgun for this unusable shotgun and why ?

Neither my wife nor my daughter have reappeared and I getting very concerned. My rich employer informed me that my family and I couldn't remain at the mansion any longer and when I suggested that I could join them tomorrow, he laughed and said that it was useless to worry myself like that.

November 21st 1967

Luggage was gathered and somebody led me into a large room, without openings, on the first floor reserved for the receptions. As the Lord

hadn't arrived yet, I was observing the painting in company of a man in a white blouse. He was one of the three unknown men on the courtyard.

"Life is rich and short". On the painting, which were exposed on the wall, time was represented by the life of a man, from his birth to his death.

"Your family died, now" -laughed the man while he was looking at me stily. Time seemed to stop. What was he talking about ? At the same moment I felt a terrible pain at the bottom of my neck, and I broke down on the floor.

November 24th 1967

How could he have become this kind of man ? What happened here ? And what is the objective of this company called "Umbrella" ?

I was imprisoned in this room and time passed slowly. "The objective is to keep all this as a secret, and since you are an unknown...". One day, a man in a white blouse said this to me while bringing revolting food.

What secret is more important than a human life ?

Lord Spencer and me are the two only ones to know the secrets of this manor, and if I die, he will be the only holder of this knowledge. Is it for that reason we have these creatures which prowl around the premises of the Manor ? I cannot remain here and be eaten of worse. It is necessary that I escape from here.

The question is to know if, since the beginning, I didn't quite simply build my own prison. When I was creating this manor, and in accordance with Lord Spencer's strange fascination for enigmas, I conceived a way to escape for whoever would find himself imprisoned there.

It would seem that Lord Spencer wants to test this method on me...

At this moment, one of the countless creatures which infest the floor and the ceiling, fell from the ceiling onto my body. For an unknown reason, it seemed to attract them. I jumped instinctively backwards and while getting upright I trampled a great number of them. What are these creatures ? Ants ?

November 27th 1967

I finally succeeded to escape from this room. But nobody can exit from the Manor on snap of a finger. You need the crests, the missing eye from the Tiger's statue and the Gold Emblem. I can't occupy myself find something else ! I have no time for this.

November 28th 1967

I can't find the words for it. A plant, absurdly gigantic, fills a whole room. God could not have created such a thing.

November 30th 1967

It is impossible to get out. It is impossible to come out of the room. A phantom laboratory, leading into a kind of underground cave without visible exit. And finally, I found it :

One of the high-heeled shoes and the memory, that behind all it I will find a passage. Jessica. Were my wife and my daughter subjected to the same destiny as me ? No, I will escape at all cost, as they did before me.

December 5th 1967

My throat is dehydrated. I didn't eat for many days and I don't know how much time I'll still resist. I am becoming insane.

Why ? Because I am like a rat, hopeless trying to escape from a laboratory labyrinth. Does my fascination for the abnormal architect of this residence was no reprehensible ?

December 7th 1967

I am in a dark and wet underground secret conduit. And there, suddenly, something monstrous opposite of me... I scrape my last match with a trembling hand. A tombstone is here with my name engraved on it. What kind of a psychopath would make a similar thing ?

"George Trevor" isn't me ? Spencer calculated since the beginning, that I would come up to here to take my breath, and prepared my tomb. Realizing, with success, to direct my attention away from each useful way to escape. Jessica, please forgive me. Little time... It's the time that remains me before joining you in paradise.

George Trevor

~~~~~  
WHERE IS JILL VALENTINE ?  
~~~~~

This title reminds you about the heroine of Resident Evil 1 - Jill Valentine. She has appears in Resident Evil 3 Nemesis with a heavy mission : Escape from the haunted Raccoon city. This adventure happens at the same time of Resident Evil 2. While Leon and Claire are wandering in the police station, Jill is looking for the way around the outside city. She is pursued by a new bio-weapon of Umbrella - Nemesis. This bio-weapon seems to be more modern and intelligent because he knows his target is the S.T.A.R.S. members and he just runs after them. With the help of Carlos - a member of Umbrella Personel, Jill with him escaped from the city which is gonna be destroyed by Umbrella to delete all the evidence about their cruel work.

~~~~~  
WESKER'S REPORT  
~~~~~

"Wesker's report" is the bonus DVD disc that will be released with Resident Evil Code Veronica X when it's sold. Some information said that its original version was released in Japan. And the purpose which Capcom release this part might be to answer some unknown questions about the game that the fans always wonder. I want to write some parts of this report for you to know few about it :

"My name is Albert Wesker.

I aspired to become a leading researcher at Umbrella Inc. A pharmaceutical enterprise who covertly conduction Bio Organic Weapons, better known as B.O.W., for development. But at the leader development training ground situated in Raccoon city, I met a brilliant and talented researcher who decided to take a different path, William Birkin.

In time I shifted my position to S.T.A.R.S., a special force unit of the Raccoon Police Department. Umbrella, for crisis management reasons of their illegal Bio Organic Weapons development had many of its people working in the police department.

I became the leader of S.T.A.R.S. and conducted all sorts of intelligence activities for Umbrella. As I continued to serve I devised my own plans and waited for the right time moment to execute them.

Then at last, opportunity knocked.

- 1998 - July 24th -

The freak murder incidents had occurred in the forest near the mansion started it all. The mansion was Umbrella's secret BOW laboratory and it was clear that the indevelopment T-virus was the cause of the murder.

Initially, Umbrella instructed me secretly to keep S.T.A.R.S. to the mansion, dispose of them, then report the situation to headquarters so that their combat with the B.O.W. could be used for data analysis allowing Umbrella a comprehensive portrait of the B.O.W.'s combat abilities.

From the two S.T.A.R.S. teams I first pitched in the Bravo Team. As expected, the top elite of S.T.A.R.S. gave all they had and became useful sample data. Then following, I geared up the Alpha Team to "search and rescue" the lost Bravo Team. The members of Alpha Team also proved their worth and as expected many died.

There were five survivors from the initial eleven S.T.A.R.S. members. From the Alpha team were Chris Redfield, Jill Valentine and Barry Burton. And from the Bravo Team were Rebecca Chambers and Enrico Marini.

It was time to begin executing my plans. In the midst of the whole affair I could take Umbrella's ultimate Bio-Organic Weapon, the Tyrant, and join forces with an opposing corporation of Umbrella. To buy into that opposing corporation I would need the actual combat data of the Tyrant.

The surviving privileged members of S.T.A.R.S. were just the perfect bait. I decided to have one of them play the Judas and draw them to the Tyrant.

That Judas was Barry.

Barry was the strong truth and justice kind and cherished his family more than anything. His type is easy to manipulate. I just took that most important thing away from him. My only miscalculation was the high potential of Chris and Jill. But with the family man Barry playing Judas the scheme went as planned.

Then the winds turn unexpectedly.

I had to eliminate Enrico who found out what was behind it all. I used Barry to get to him. After I successfully got rid of that nuisance I awaited the sample specimen that Barry would bring to me in the Tyrant room.

I injected the virus I obtained from Birkin in advance. If I made Umbrella believe I was dead, it made it far more convenient to sell myself to the opposing corporation. According to Birkin the virus had profound effects. It would put my body in a state of temporary "death". It would then bring me back to life with super human powers. Therefore I unleashed an awesome Tyrant from its slumber and let it attack me.

As my consciousness faded away I was certain that the whole scheme would end in success.

Never did I imagine that S.T.A.R.S. could slay the evil creation. I lost the Tyrant and the plan I devised which cost me my humanity ended in failure. Now anything and anyone who stood in my way would be terminated. It's been that way for a long time and it always will be. At all cost I had to make S.T.A.R.S. pay.

- September -

Two months had passed since the mansion incident. To regain everything I had lost in my new organization I joined hands with Ada Wong, a female agent who was also sent to spy on Umbrella.

I knew in my bones that the key developer was William Birkin, but what he didn't know was that Umbrella did not play games...with anyone. Eventually, Birkin would be assassinated, and the G-virus would be in the hands of Umbrella.

But the salvage team led by Hunk was ahead of us. By the time they got to Birkin, he'd already injected himself with the G-virus...he became his own creation, and decimated them.

Soon after, the T-virus carried by rats spread throughout Raccoon

city, and Umbrella faced its worst scenario.

- September 28th -

The good citizens became zombies, and the city had headed for its devastating fate. Humans were no match against zombies.

In the chaos, Umbrella Europe applied a new type B.O.W., called "Nemesis". The Nemesis would hunt down and destroy the surviving member of S.T.A.R.S., Jill. It became imperative that our organization would also obtain the Nemesis data.

- September 29th -

To cover up the whole affair, Umbrella jettisoned a Tyrant to take care of Leon and Claire, who were trying to unveil their secrets.

Then, a new revelation. Birkin used to hide the findings of his studies in his daughter Sherry's pendant. It was very possible that the G-virus was there. While Umbrella was busy with their cover up, we had to capture Sherry before they did. I sent Ada undercover to seek the location of Sherry. I, the "dead man" on the other hand, had to work in the shadows.

A spy's obligation and priority is in mission, to carry out the mission like a machine without any emotional interference.

But through her interaction and involvement with Leon Scott Kennedy, there had been an affection growing inside her.

My instincts sensed danger, something had to be done, quickly. My instincts did not disappoint me. Even though Ada almost had her hands on the G-virus, which Leon had acquired from Sherry, that affection of her drove her to her death. But she was still of some use. I had to save her life. My people hurried to retrieve the G-virus that Leon threw away. But Hunk, the only survivor of Umbrella's salvage team, was there before us.

- September 30th -

Our only option left was to bring back Birkin, the monster, as the sample specimen and have him finish Leon and Claire in order to obtain his combat data. Although Birkin lost the battle to Leon and Claire, we succeeded in gathering samples of the G-virus from his dead body.

- October 1st -

In the morning the government bombed Raccoon city in an attempt to stop for the viral outbreak. This was, of course, their feigned reason...

Later, Claire left to Europe to find her lost brother Chris, and Leon joined forces with an underground anti-Umbrella organization.

Sherry is safe in our hands. I would never underestimate Birkin. There's something about this little girl...

\* Source : Biohazardextreme.

-----

Okay, this passage has just been written half. I'll continue if there are more info.

But all of you know that it answers you some unknown questions that you always wonder. Let me give them in this short passage :

- The survivors of the mansion incident were Chris Redfield, Jill Valentine, Barry Burton, Rebecca Chamber and Brad Vickers.

- Chris is the character who directly killed Tyrant.

- Wesker was killed by Tyrant. But he had been infected the virus before that makes him alive.

- Ada was saved by Wesker because he thought she's still useful for him. She stole the G-virus for him.
- Sherry was caught by Wesker after Resident Evil 2 with the same reason.
- The official story of Resident Evil 2 is Leon A / Claire B.

~~~~~

RESIDENT EVIL GAMES

~~~~~

NAME : Resident Evil  
RELEASED DATE : 1996 - 1997  
PLATFORM : Playstation, PC, Sega Saturn

This was the first Resident Evil of series. Its content is about the incident in a mansion belonging Raccoon Forest. This involves the Trevor's Note I wrote above. You take the role of either Chris Redfield and Jill Valentine - two members STARS to explore the mansion.

NAME : Resident Evil Director's Cut  
RELEASED DATE : 1997-1998  
PLATFORM : Playstation  
It's almost the same as original Resident Evil with more modes and features.

NAME : Resident Evil Director's Cut Dual Shock Edition  
RELEASED DATE : 1997-1998  
PLATFORM : Playstation  
It's almost the same as Resident Evil Director's Cut.

NAME : Resident Evil 3 Nemesis  
RELEASED DATE : 1999-2000  
PLATFORM : Playstation, Dreamcast, PC.  
You take the main role of Jill Valentine to escape from Raccoon City which is going be destroyed by Umbrella to wipe all the evidence about the virus. She was one of the survivor of the mansion incident who knows about this work. So Umbrella creates Nemesis to pursue her.

NAME : Resident Evil Gun Survivor  
RELEASED DATE : 2000  
PLATFORM : Playstation  
You are a person who is injured by an accident. He forgets everything about himself and tries to find the truth. In his journey, he is watched by a guy of Umbrella named Vincent. Later the main character realizes himself as Ark Thompson. He destroys an important facility of Umbrella and escapes with Lott and Lily - the two children he meets on his way.

NAME : Resident Evil Code Veronica  
RELEASED DATE : 2000  
PLATFORM : Dreamcast, GameCube  
You again take role of Claire Redfield. But now it's not an accidental journey in Raccoon City. After Resident Evil 2, Claire decides to look for her lost brother Chris Redfield who is doubted to be in Europe. But when seeking, she unintentionally spots something important about Umbrella and is caught by them...

NAME : Biohazard Code Veronica Complete  
RELEASED DATE : 2000-2001  
PLATFORM : Dreamcast  
It's the same story as Resident Evil Code Veronica. But it has some extra cut scenes about the main villain of Resident Evil series -

Albert Wesker. This disc has a bonus demo of Devil May Cry - a new game of Capcom. Beside this game there are some additional packages released either.

NAME : Resident Evil Code Veronica X  
RELEASED DATE : 2001  
PLATFORM : Playstation 2

It's the same as Biohazard Code Veronica Complete, but with a bonus DVD Wesker's Report which Capcom released to answer some unknown episodes of the game which the players often wonder.

NAME : Resident Evil 0  
RELEASE DATE : Early 2002  
PLATFORM : GameCube

This game was released first for Gameboy. But now it has been redoing with this new console. This scenario lets us know more about Rebecca Champer - the support character in Resident Evil who rarely appears. You also have a chance to know more about STARS and Umbrella in this game.

NAME : Resident Evil Gaiden  
RELEASE DATE : Fall 2002  
PLATFORM : Gameboy Color

This is a new scenario and also a chance for the Resident Evil fans who like the character Barry Burton of the first Resident Evil. He would be the main character of the game and start his adventure on a ship. This is just a rumour.

NAME : Resident Evil 4  
RELEASE DATE : Early 2002  
PLATFORM : GameCube

Have you enjoyed enough Resident Evil Code Veronica ? And Resident Evil 4 would give you the next answers of the Resident Evil story. There are rumours that this game would be an impression of Capcom about graphic and other systems. There are tons of stupid rumours about characters. But I can't tell which is right. No more information is received this time. I think this game is still so far.

~~~~~\  
MY OWN REVIEW ABOUT THIS GAME \~~~~~  
~~~~~

Oh yeah, passing the adventures of Resident Evil series, I think Resident Evil 2 is the most. But why don't I give it the best score ? Just because I'm telling my current feeling. If I wrote this review two years ago, the score would be highest. Now Resident Evil 2 can't be compared with the later Resident Evils with best graphic and modern system.

Gameplay 10/10

The game is long enough for the players to play whenever they want, not too long, not too short. There are many thrilling episodes and good puzzles in the game that make it more exciting. Mini-game, secret scenarios help it to be more various. Each time we play, we can find a lot of new things that we haven't paid attention to before. The game is always for us. Yes, it's really interesting.

Storyline 8/10

It continues the mansion incident in Resident Evil 1. The whole city was haunted by strange creatures. No one knew what had been happening.

Leon and Claire were lost in the dark city. In Police Station, they find more clues about Umbrella Corporation. This story is not bad. But I still hope it would be more episodes.

#### Graphic 8/10

The graphic is good, better than Resident Evil 1. Its graphic can be compared with the later Resident Evil 3 Nemesis. The colours are clear with right brightness. The camera angles are put well. But I think it needs to be repaired a little. But there's one thing : When the characters talk to each other, their mouths don't open to say. I only hear the voice when their mouths "say" nothing. Why does Capcom let this ? Or just because the simple graphic ?

#### Sounds 10/10

The sound system is the best. The steps of characters are sounded well and clearly. The shout of monster William is very lively and real. The background music is not only horror but makes us jump as well.

#### Mini-games 10/10

The secret scenarios are hidden so well that some of players couldn't find or pay attention. In addition to this, mini-game help us to know more small parts in the whole story of Resident Evil series. Capcom is good to let us know these small parts by a terrific mini-game.

#### Replayability 10/10

As I wrote, the game is attractive enough for you to play many times. You'll be fond of it and try to find all the secrets of this game... even if you play Resident Evil the first time.

To rent or buy ?

Buy !!! Why not !!!

Overall score : 8/10 (not an average)

\*\*\*\*\*

### 23. A U T H O R ' S L A S T W O R D S

\*\*\*\*\*

Is it enough information for you to know about this game ? I'm very fond of it and I'm willing to receive any of your good ideas. I'm not good at playing games or making FAQs so I hope everyone would sympathize and have ideas about my mistakes.

There's one thing I want to tell you. Although I'm still a pupil who have to go to school, I would try to have a time for checking your emails about any problems in my guide. I have ever been a player who needs others' helps and I have been disappointed when they didn't reply my questions. So I understand how you think. Just contact me at my email address anything you want. I'll try to answer your problems and won't make you disappointed. But I won't answer any emails with bad purpose or hate emails. It's just a waste of time. But I'm willing to serve anyone who really need my help.

See my other FAQs at GameFAQs :

[Http://www.gamefaqs.com/features/recognition/10477.html](http://www.gamefaqs.com/features/recognition/10477.html)

Related FAQs :



Resident Evil 2 for Dreamcast FAQ/Walkthrough  
Resident Evil 2 for PC FAQ/Walkthrough

Again, thank you to read my FAQs.

\*\*\*\*\*

#### 24. S P E C I A L T H A N K S

\*\*\*\*\*

I send my special thanks to :

- [Http://www.survivor.com](http://www.survivor.com) - for info about Related Resident Evil 2.
- [Http://residentevil.emugaming.com](http://residentevil.emugaming.com) - for info about ranking system and maps.
- [Http://www.videogames.com](http://www.videogames.com) - for laboratory maps
- Jeff "CJayC" Veasay from Gamefaqs - for posting my FAQs on your site.
- [Http://www.psxcodez.com](http://www.psxcodez.com) - for displaying this guide on their site.
- Hellraiser from Yahoo Club-for choosing my guide on your site.
- Capcom - for creating this game
- This game - for giving me a good chance to write this FAQs.
- Xfactor from Gamefaqs message board - for repairing my mistakes
- Everybody in Resident Evil 2 Message board - for a lot of important info you let me know, and the name of G-Infant.

Repeatedly, Thanks Everyone.

-----

Again, this guide is owned by :  
PHAN NGUYEN KHANH DAN  
"MYSTICCAT"

This document is copyright Mysticcat and hosted by VGM with permission.