

SNS-CW-USA

SUPER **NINJA BOY**™



INSTRUCTION BOOKLET

 **CULTURE BRAIN**™

SUPER NINTENDO
ENTERTAINMENT SYSTEM



WARNING: PLEASE READ THE ENCLOSED CONSUMER INFORMATION AND PRECAUTIONS BOOKLET CAREFULLY BEFORE USING YOUR NINTENDO® HARDWARE SYSTEM OR GAME PAK.



LICENSED BY



NINTENDO, SUPER NINTENDO ENTERTAINMENT SYSTEM AND THE OFFICIAL SEALS ARE REGISTERED TRADEMARKS OF NINTENDO OF AMERICA INC.
© 1991 NINTENDO OF AMERICA INC.

THIS OFFICIAL SEAL IS YOUR ASSURANCE THAT NINTENDO HAS APPROVED THE QUALITY OF THIS PRODUCT. ALWAYS LOOK FOR THIS SEAL WHEN BUYING GAMES AND ACCESSORIES TO ENSURE COMPLETE COMPATIBILITY WITH YOUR SUPER NINTENDO ENTERTAINMENT SYSTEM. ALL NINTENDO PRODUCTS ARE LICENSED BY SALE FOR USE ONLY WITH OTHER AUTHORIZED PRODUCTS BEARING THE OFFICIAL NINTENDO SEAL OF QUALITY.

Thank you very much for purchasing CULTURE BRAIN's "SUPER NINJA BOY" for your Super Nintendo Entertainment System.

For maximum enjoyment, please read this instruction booklet thoroughly before playing.

● CONTENTS

| | |
|---|----|
| ● BEFORE YOU START | 4 |
| ● PROLOGUE (STORY) | 5 |
| ● JACK AND RYU'S HUMOROUS NINJA ACTIONS | 8 |
| ● LET'S START THE GAME | 15 |
| ● HOW TO USE PASSWORDS | 16 |
| ● LET'S EXPLORE THE CHINALAND | 18 |
| ● VIEWING AND USING THE SUBSCREEN | 22 |
| ● TYPES OF BATTLES | 26 |
| ● HOW TO MANAGE THE COMMAND BATTLE | 28 |

ITEM IN THE ACTION STAGE

DRAGON EGG

An egg of a dragon. If you use it in the Special Field Stage, the dragon will show up and will help Jack and Ryu to move through the air.

Dragon Eggs have another effect besides its prior effect as an air transporter. Even when you consume all the HP in the Special Field Stage, with an Egg, you can resume the game from the beginning of the athletic stage without going all the way back to a convenience store. It costs you one Egg at a time.

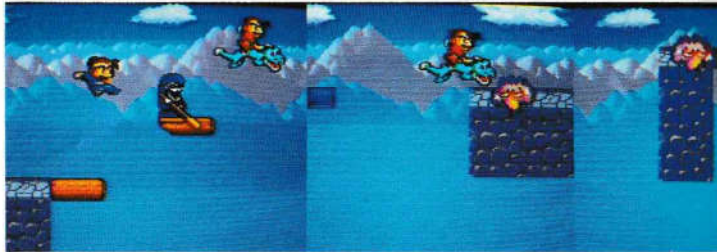

CONTROLLER OPERATION

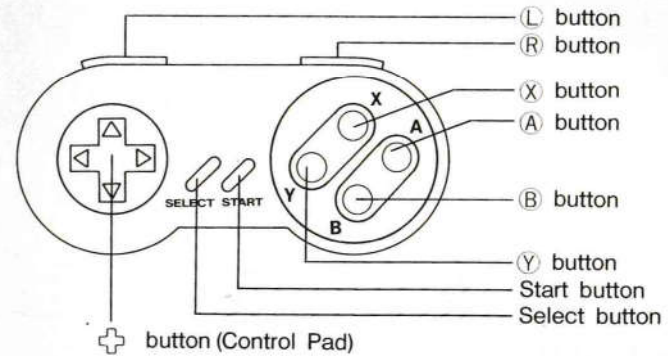

BASIC OPERATION

- + buttonMove
- Y buttonPunch
- B buttonJump
- B + + buttonMoonsault kick
- A + + buttonMiracle kick
- Start buttonBrings up subscreen
(The B button puts you to the original screen)
- I Controller.....Jack
- II Controller.....Ryu

JACK AND RYU'S HUMOROUS NINJA ACTIONS! 1

MOVE

Pressing the **+** button can move Jack and Ryu as you like.



PUNCH

Press the **Y** button to throw a punch. Punch items make your punches more destructive. If the button is pressed rapidly, you may be able to give a powerful straight punch, or pick up the enemy and throw them.

Certain kinds of punches can't use throwing techniques.

Make sure to bring some Dragon Eggs when you go to a Special Field Stage. If you fall into a pit, press the **START** button to get to a subscreen to use the Egg. Use this technique wisely to get out of troubles.

JACK AND RYU'S HUMOROUS NINJA ACTIONS! 2

JUMP

Press the **B** button to jump. While jumping, press the **+** button to move right and left.



MOONSAULT KICK

Hold down the **+** button and press the **B** button to give the enemy Moonsault Kicks. You can choose 4 different directions.

MIRACLE KICK

Hold down the **+** button and press the **A** button to use the Miracle Kick which is more powerful than the Moonsault Kick.

But the Miracle Kick consumes 1 NP point.



CYCLONE KICK

You can spin and kick enemies by pressing the **B** and **Y** at the same time. You can give great damage especially when you're surrounded by multiple numbers of enemies. But be aware that the technique consumes 1 NP point.

JACK AND RYU'S HUMOROUS NINJA ACTIONS! 2

SUPER RUN

Hold down the **Y** button and press the control pad in the direction your character runs. He'll run super fast!

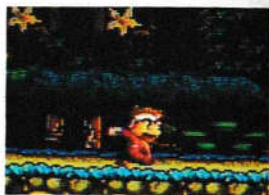

SUPER JUMP

When pressing the **B** button while your character is in the middle of Super Run, you can use the Super Jump. There are some big holes that you must use Super Jump to cross over. Be well-prepared for that.

BREAK ATTACK

Pressing the control pad in the opposite direction your character is running while in Super Run, puts on the brakes. If you hit against the enemy, you may be able to throw him.

Note: You can throw enemies, but you can't give them damages.



NINJA CYCLONE

After collecting three **M** marks, bring up the subscreen and select Ninja Cyclone from the "EQUIPMENT" command. It is available after the music changes. While you're in Super Run, press the **B** button to use the technique.

JACK AND RYU'S HUMOROUS NINJA ACTIONS! 3

STICKING TO THE WALL

In the Special Field Stage, Jack and Ryu can stick to the wall.

Jump your character to the wall and press the **+** button up or down to move him.

To detach, press the **+** button in the opposite direction your character faces, and the **B** button.



ROPE

Jump your character to the rope and press the **+** button up or down to move him.

To detach, press the **+** button in the opposite direction your character faces and the **B** button.

STICKING TO THE CEILING

If your character has Ninja Spider Shoes on, he can stick to the ceiling by pressing the **B** button. To detach, press the **B** button again.



JACK AND RYU'S HUMOROUS NINJA ACTIONS! 3

THROWING STARS (T-STARS)

Our heroes can be equipped with the T-Stars. They can throw stars and defeat the enemy at the same time.



DEFEAT ENEMIES WITH T-STARS

There are 4 different kinds of T-Stars available for your character.

MIGHTY BALLS

Your character can use the Mighty Balls if he has collected 3 (M) marks that appear from the punched rocks.

Select command "EQUIP", choose Mighty Balls, and grab the "M" ball as soon as it appears.

It is the invincible attack !!!



JACK AND RYU'S HUMOROUS NINJA ACTIONS! 4

CHARACTERS ON THE GROUND

Press the (Y) button to lift up the characters on the ground.

Press the (Y) button one more time to throw them.



PICKING UP A SWORD

When your character gets to the sword, press the (Y) button to pick it up. He can only use it during the same fight.

TOWER MEGA-ATTACK

In the 2 player mode, your character can stick to the wall and jump with his partner on his shoulders.

If you press the (Y) button, however, you will throw your partner.

Be careful !!!



BE COOPERATIVE !!!

Since you have your partner, don't fight separately.
Here are some examples you can use with your partner.



Sticking to the Wall



Rope

There are more humorous actions you have to discover by yourself.
Good luck !!!

Some of your enemies who attach to you will drain your power and try to stop your movements. For those enemies use the  button to move right or left. They will be detached.
(Or press the (A), (B) buttons rapidly.)

LET'S START THE GAME !!!



(1) To start the game from the beginning, select "START"; to continue where you left off, select "PASSWORD".

(See Page 16)



(2) How many players?

Choose if you want to play in the 1 or 2 player mode.

If you select the 1 player mode, Jack will be your character.
In the 2 player mode, 1P is Jack and 2P is Ryu.

(3) Select difficulties of the action play.

Three modes (Hard, Normal, and Easy) are available to you.



NOTE

The difficulty that you have chosen doesn't record in the password. You can change the difficulty whenever you restart the game where you left off. After selecting the difficulty, enter the password.

HOW TO USE PASSWORDS

Don't forget to write the password down before you quit the game. Passwords enable you to resume where you left off. Passwords are given in both the subscreen and in the "Convenience Store".



(1) Subscreens

You can get them anywhere. Bring up the subscreen and select "Password".



(2) Convenience Store

The stores are located in every town. You can ask for passwords.

ENTER THE PASSWORDS!



To enter the password, select "Password" from the title screen. If you are defeated and wish to continue the last game, the password will return you to the "Convenience Store" from where you last received it. When you go to a new town, don't forget to stop by the "Convenience Store" to get the password.

NOTE

In the 2 player mode, both Jack and Ryu grow up together. Even if Ryu joined in the middle of the game, the power of the characters will be the same. Only one password applies to both Jack and Ryu.

LET'S EXPLORE THE CHINALAND



This is the Field Map of Chinaland !!

Controller Operation of the Map Screen

⊕ BUTTON Moves Jack, Ryu, vessels, and aircrafts up, down, left and right.
(Control Pad)

START BUTTON Brings up the subscreen.
The B button lets you go back to the original screen.

VESSELS/AIRCRAFTS

Vessels are Arc-de-Travel, Shark Cruiser, and Sub-CYCLONE which are available in the map screen.

Bigbot is an aircraft. It is also available in the map screen by pressing the Y button.

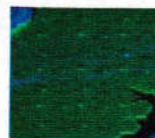

It's a landform.
Get on here by Bigbot.



People of Chinaland live here.

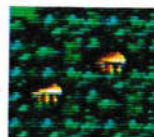

There are many trees.
You can't get on by Bigbot.



A mysterious tower.
Who lives in here ???



You can walk into green mountains, but can't walk into brown ones.



A landing place.
You can get on or get off from here by Arc-de-Travel or Shark Cruiser.



An entrance to an underground maze.



Go into the sea by Sub-CYCLONE

HOW TO USE "COMMAND" IN THE TOWN !



It is very important for Jack and Ryu to visit people in the town. Get all the information you can get !!!

Let's get information in the town !

When you talk to people in the town, walk to the person you wish to talk to, and press the (A) button.



CONVENIENCE STORES



It is rumored that "Convenience Stores" are from a divine place. It is very convenient. You can buy revival medicine, or alternate number of players. Don't forget to get passwords.

ITEM SHOP



You can find various convenient tools.

INN



Rest at a hotel when you're exhausted. Your power will be fully charged.

BUILDING 1

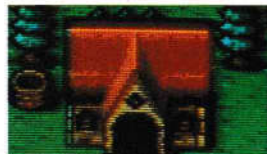

People who want to help Jack and Ryu live in this building.

BUILDING 2



If the door is closed, you can't enter a building.

VIEWING AND USING THE SUBSCREEN

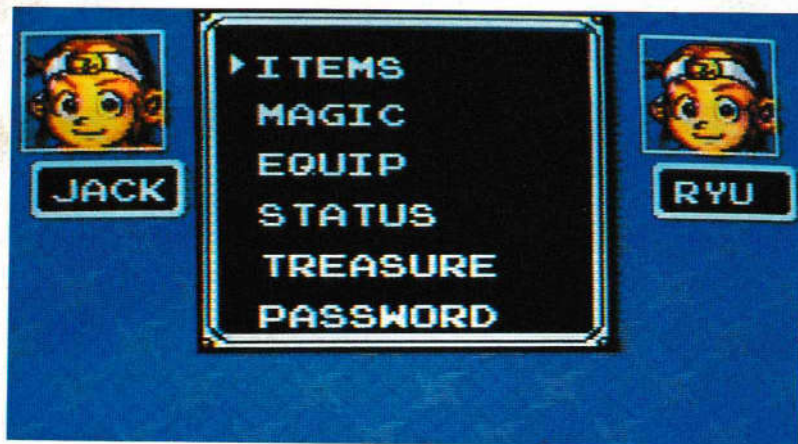

If you press the START button in the map screen, it will display the subscreen.

The subscreen lets you select the items and confirm various situations.

STATUS

Indicates strength of Jack and Ryu. EX means experience points. As you defeat enemies, your experience points will increase and the level advances. The levels indicate your skill. The higher the level, the stronger your characters are.

EQUIP.

Displays the weapons and shields you currently have. The items you can have are: punch-ups, swords, shields, robes, helmets, throwing stars, and LV counters. (Throwing stars are the only item you can carry more than one of.)

TREASURE

Displays all the treasures you have collected.

MONEY

Indicates the amount of money you have.

If you are defeated, your amount of money will be cut in half.

The amount of the money available can be checked on the STATUS screen.

ITEMS

Displays the tools Jack and Ryu have at the current moment.

Move the cursor around and press the (A) button to use them.

MAGIC

Displays the ninja actions that Jack and Ryu can use.

Move the cursor around and press the (A) button.

You must have NP's to use them.

In the 2 player mode, items, strength, treasures, money, and so forth are shared between two. You can't collect the items separately. Be cooperative, and use the available items wisely.

VIEWING AND USING THE SUBSCREEN (2)

How To Use Errandbots



(1) Errandbots will get you things that are away from Jack and Ryu.

Let's Select Errandbots for Items !!!



(Figure 1)

(1) Displays an item list, select any items you want to have.

Remember you can't use Errandbots if your character is in the middle of a battle or in the middle of an underground maze.

After Selecting A Bonzebot



(1) If your partner is defeated and you need help, you can ask Bonzebot for help.



(2) Yeah!! My partner is back.
Thank you, Bonzebot!

IF YOU CHOOSE THE SUBSCREEN DURING THE BATTLE.....



This command is a little bit different than in the original subscreen, but the ITEMS and MAGIC are the same.

How About Equipment ???



(1) If you choose "EQUIP" from the subscreen during the battle, this screen will show up.



(2) Your character can be equipped with the special sword and Mighty Ball

TYPES OF BATTLES

There are two kinds of command battles.



(1) FIELD BATTLE

While adventuring on the map, the screen suddenly sends you to this Field Battle. If you defeat a certain number of enemies, you can be a winner. Enemies that you throw into holes are not counted, however.



(2) Special Field Stage

If you go to certain spots in the map, you could be sent to this Special Field Stage. What you need to do in here is just keep going forward and you will see a goal.

HOW TO VIEW THE DISPLAY INDICATOR



- JACKPlayer 1
- RYUPlayer 2
- LVThe Level of the Player
- (M)(M) Marks
- H P (1)Damage Point of Player 1
- H P (2)Damage Point of Player 2
- N P (1)Ninja Point of Player 1
- N P (2)Ninja Point of Player 2

If you are playing in Player 1 mode, the display indicator shows only Player 1.

HOW TO MANAGE THE COMMAND BATTLE

COMMAND BATTLE SCREEN



Encounter enemy leaders in command battles.

Ryu will join Jack to reinforce the attack in 1 Player mode.

COMMAND

- FIGHT**Select FIGHT command for automatic punch and kick attacks.
- ITEM**Select ITEM for display of available items. Place the cursor to the item and press the (A) button to choose.
- MAGIC**Select MAGIC for a display of available magic. Follow the same procedure as above to choose one. Magic can't be used without the proper NP.
- RUN**Use this command when you don't want to fight.

NINJA MAGIC



Vitalizer

Recovers 40 physical strength points.



Magiport

Takes your character back to where he got the last password.



Turtle Watch

Slows enemies down.



Hyper Vision

Lights up invisible enemies.



Serenitech

Makes your character invisible by calming himself down, but doesn't work in the dungeon. On the screen you won't see anything different, however. Some enemies are affected by this Serenitech but some are not.



Spider Shoes

Allows your character to walk upside down on the ceiling.



Magidoor

Allows you to escape from the dungeon.



T-Stars

There are 4 different kinds of Throwing stars. Each has a distinctive effect.

NINJA ITEMS !!!



(1) ESCAPE LEAF

This mysterious leaf will pull you out of the battlefield.



(2) MICRO NINJA

This magic shrinks your body into a midget. It's a useful magic especially when you run through a narrow path.



(3) DE TECOY

This magic creates your double to attract the enemies' attention. Attack them while it's distracting the enemies.



(4) MAGIC WIND

This magic makes a gust of wind which causes damage to enemies. You may be able to blow enemies away with one gust.

ITEMS



Sweet Bun

Recovers 40 physical strength points.



Dragon Egg

A dragon will appear to help you travel in the air.



Meat Bun

Is a speciality of Chinaland. It is expensive but recovers physical strength up to its maximum points.

Errandbot

Does errands for you. See p.24 for details.

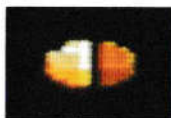

Capsule

Frees you from an enemy's magic.

Bonzebot

Can revive your defeated partner.



Boo Bomb

Gives enemies great damage and destroys specific walls in the dungeon.

ITEMS YOU CAN EQUIP



Punch

This is essential. It increases the power of punches.



Shield

Is a very useful item to repel enemy's spells.



Sword

Increases attacking power and a longer reach to the enemies.



Helmet

Helps reduce damage from enemies. It's ideal to have with Armor.



Armor

Helps reduce damages from enemies.



LV Counter

Measures enemy's physical strength. Compare yours with the enemy's before encountering him.

This screen shows the enemy's level.



ITEMS YOU CAN OBTAIN IN THE BATTLE



Sword & Nunchuck

There are two ways to obtain these ; by crushing rocks or snatching it from the enemies.



Boo Bomb

Same as the one introduced in ITEMS. The more bombs, the better.



Potsticker

Recovers 30 physical strength points. When playing in 2 player mode, both Jack and Ryu recover.



M Mark

Collect 3 of them to use the Mighty Ball and Ninja Cyclone. When you hit certain blocks, the "P" mark will appear. Hit the mark again, and you will get either M or ☹. You can save up to 15 M marks or lose 1 M marks by getting the ☹ mark.

NOTE

Swords and nunchucks found in a battle field are good only for that battle. Use them effectively while you can because you'll lose them after the battle.

CULTURE BRAIN USA, INC. LIMITED WARRANTY

CULTURE BRAIN USA, INC. warrants to the original purchaser only of this CULTURE BRAIN software product that the medium on which this computer program is recorded is free from defects in materials and workmanship for a period of ninety (90) days from the date of purchase. This CULTURE BRAIN software program is sold "as is," without express or implied warranty of any kind, and CULTURE BRAIN is not liable for any losses or damages of any kind resulting from use of this program. CULTURE BRAIN agrees for a period of ninety (90) days to either repair or replace, at its option, free of charge, any CULTURE BRAIN software product, postage paid with proof of date of purchase at its Factory Service Center. Replacement of the game pak free of charge to the original purchaser (except for the cost of returning the game pak) is the full extent of our liability.

This warranty is not applicable to normal wear and tear. This warranty shall not be applicable and shall be void if the defect in the CULTURE BRAIN software product has arisen through abuse, unreasonable use, mistreatment or neglect. THIS WARRANTY IS IN LIEU OF ALL OTHER WARRANTIES AND NO OTHER REPRESENTATIONS OR CLAIMS OF ANY NATURE SHALL BE BINDING ON OR OBLIGATE CULTURE BRAIN. ANY IMPLIED WARRANTIES APPLICABLE TO THIS SOFTWARE PRODUCT INCLUDING WARRANTIES OF MERCHANTABILITY AND FITNESS FOR A PARTICULAR PURPOSE, ARE LIMITED TO THE NINETY (90) DAY PERIOD DESCRIBED ABOVE. IN NO EVENT WILL CULTURE BRAIN BE LIABLE FOR ANY SPECIAL INCIDENTAL OR CONSEQUENTIAL DAMAGES RESULTING FROM POSSESSION, USE OR MALFUNCTION OF THIS CULTURE BRAIN SOFTWARE PRODUCT.

Some states do not allow limitations as to how long an implied warranty lasts and / or exclusions for limitations of incidental or consequential damages so the above limitations and / or exclusions of liability may not apply to you. This warranty gives you specific rights, and you may also have other rights which vary from state to state.

This warranty shall not be applicable to the extent that any provision of this warranty is prohibited by any federal, state or municipal law which cannot be pre-empted. CULTURE BRAIN USA, INC. BLDG. D-130 18133 N.E. 68TH ST. REDMOND, WA 98052 Tel. 206-882-2339



Distributed and marketed by CULTURE BRAIN USA, INC., Bldg. D-130, 18133 NE 68th St. Redmond, WA 98052. Nintendo® and Super Nintendo Entertainment System are trademarks of Nintendo of America Inc. CULTURE BRAIN™ is a trademark of CULTURE BRAIN USA, INC. Package designed and produced by CULTURE BRAIN INC. TM and © 1992 CULTURE BRAIN USA, INC. All rights reserved.

Printed in Japan